



**Iseas**  
*Pioneering Spirit*



**Manual**

**1**



# Step 01



M38-70093



# Step 02

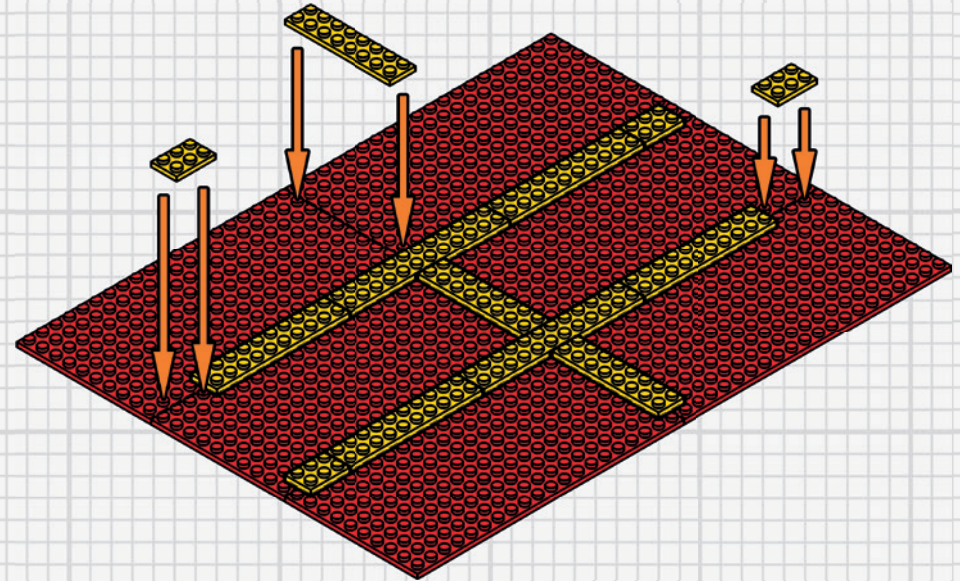
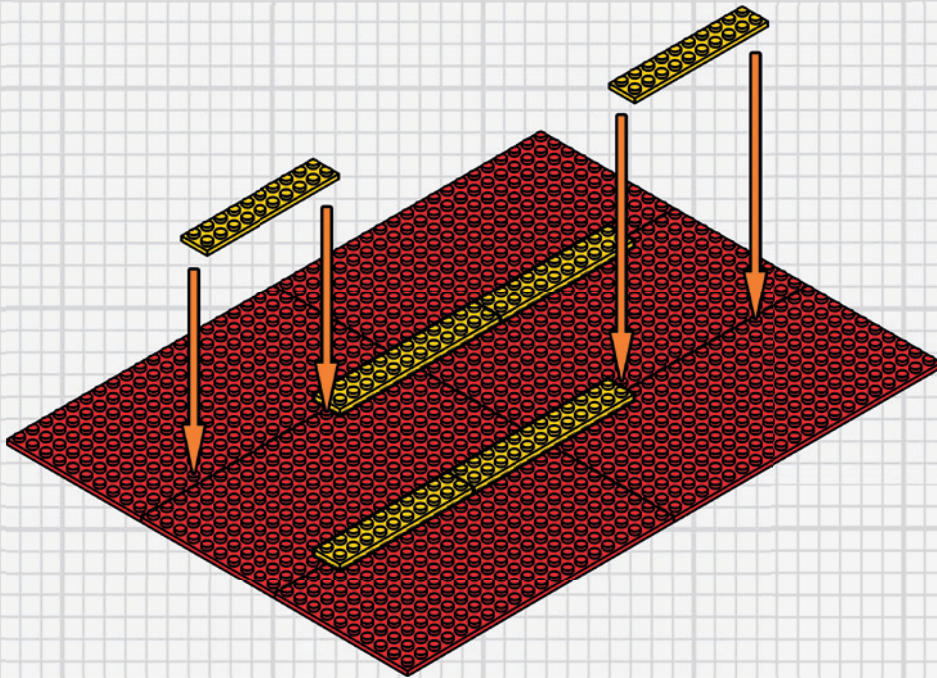
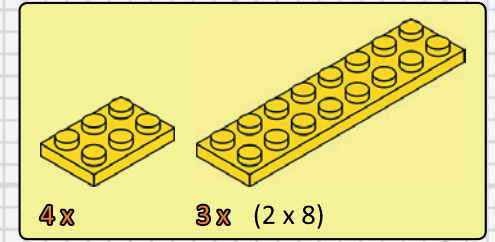
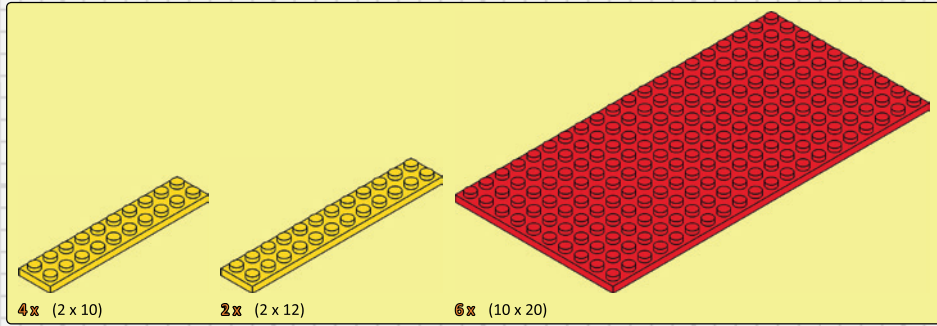



# Step 03



M38-70093



elseas

# Step 04

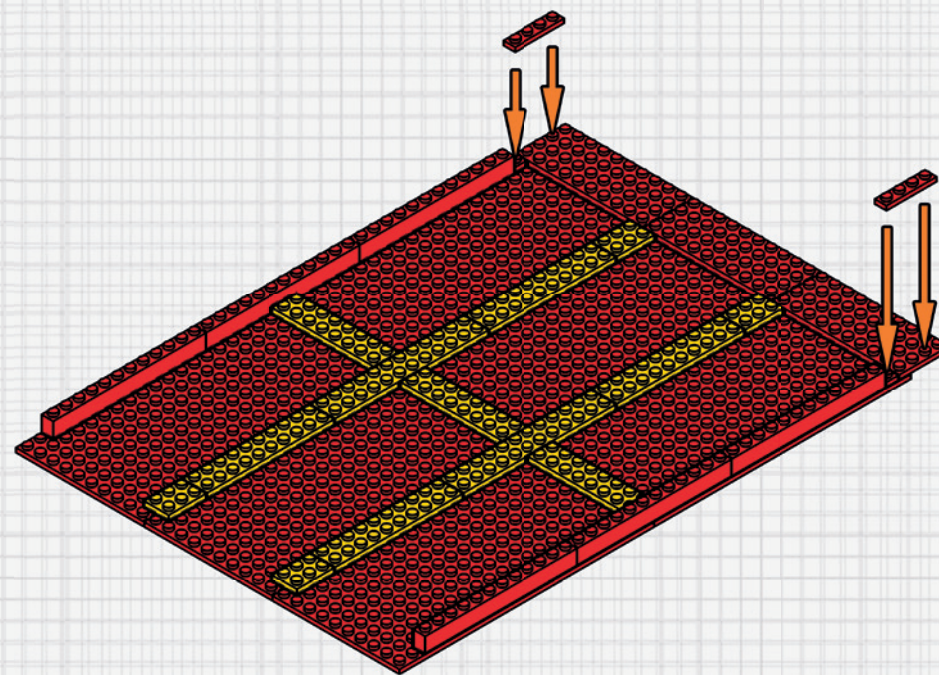
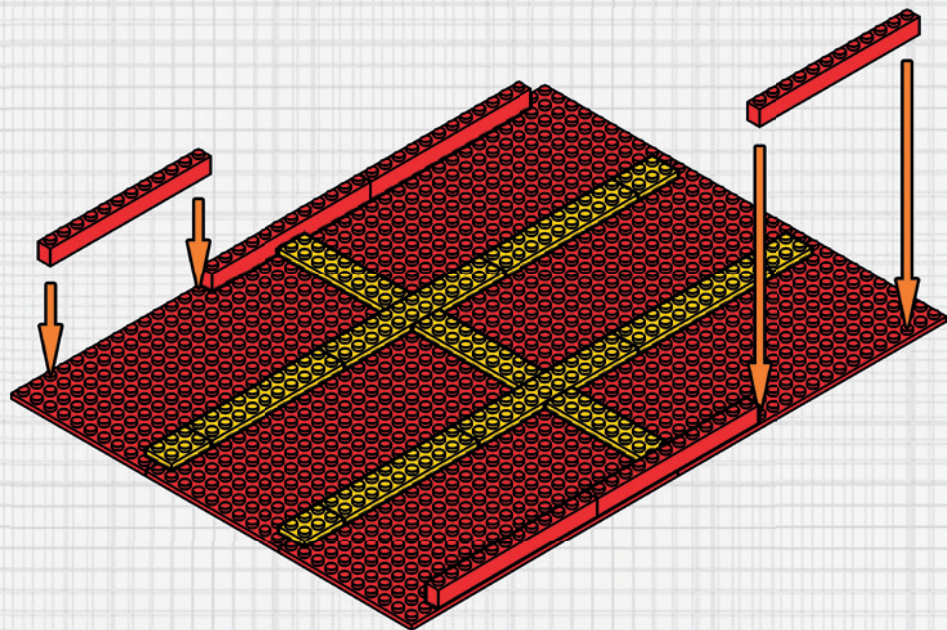
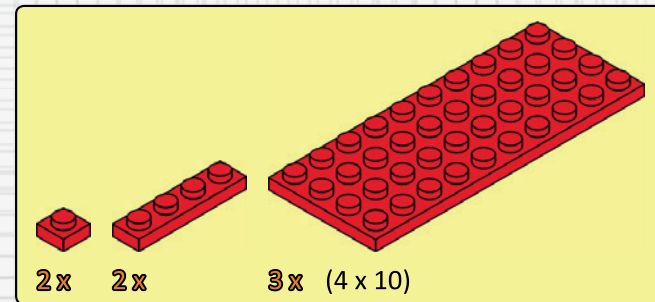
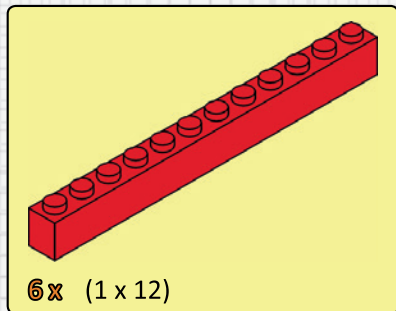



# Step 05



M38-70093



elseas

# Step 06

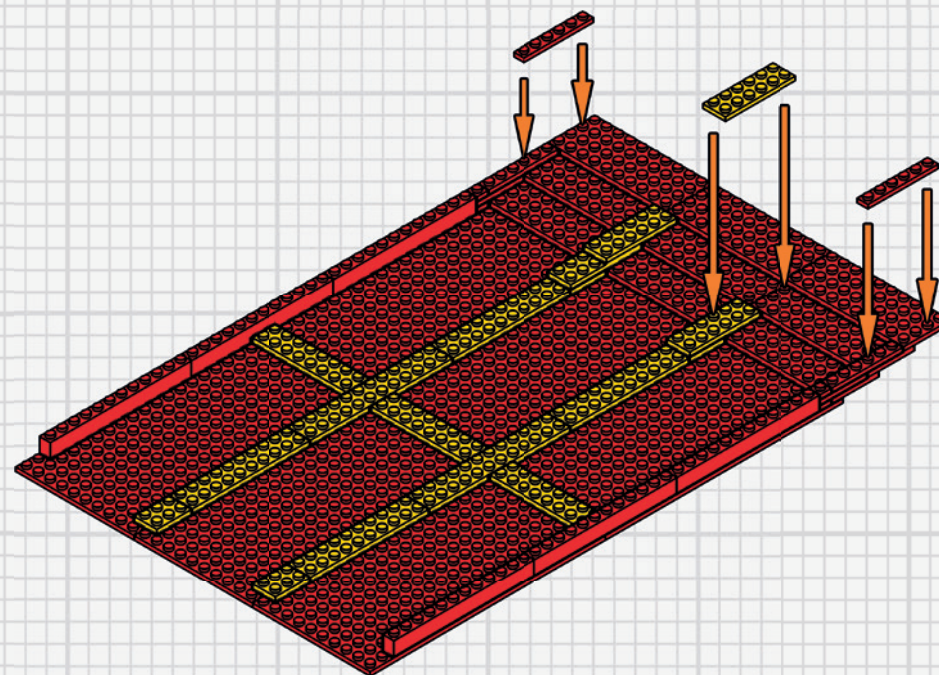
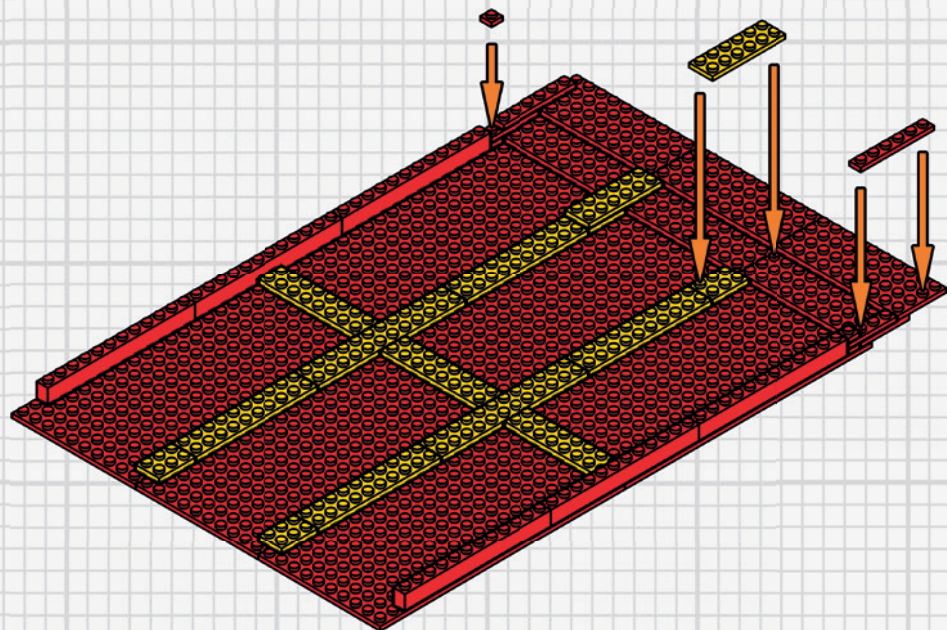
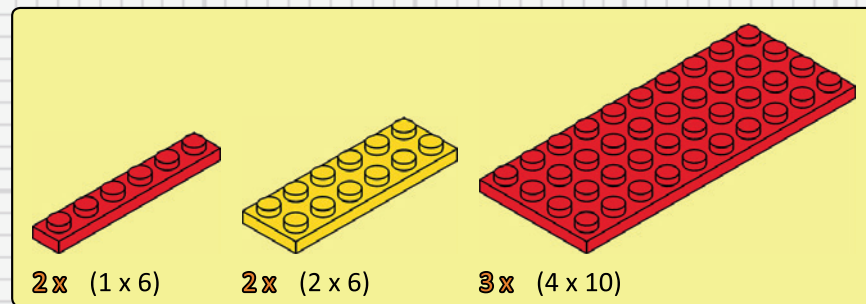
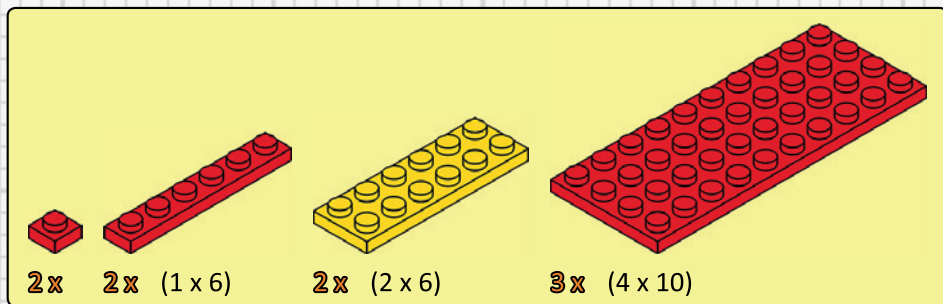



# Step 07



M38-70093



# Step 08

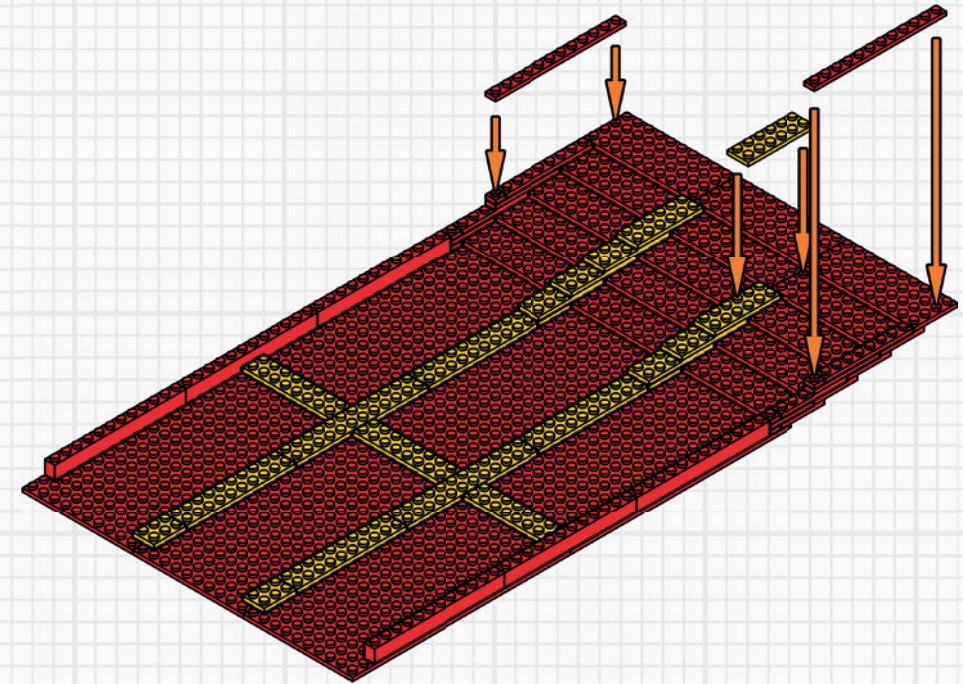
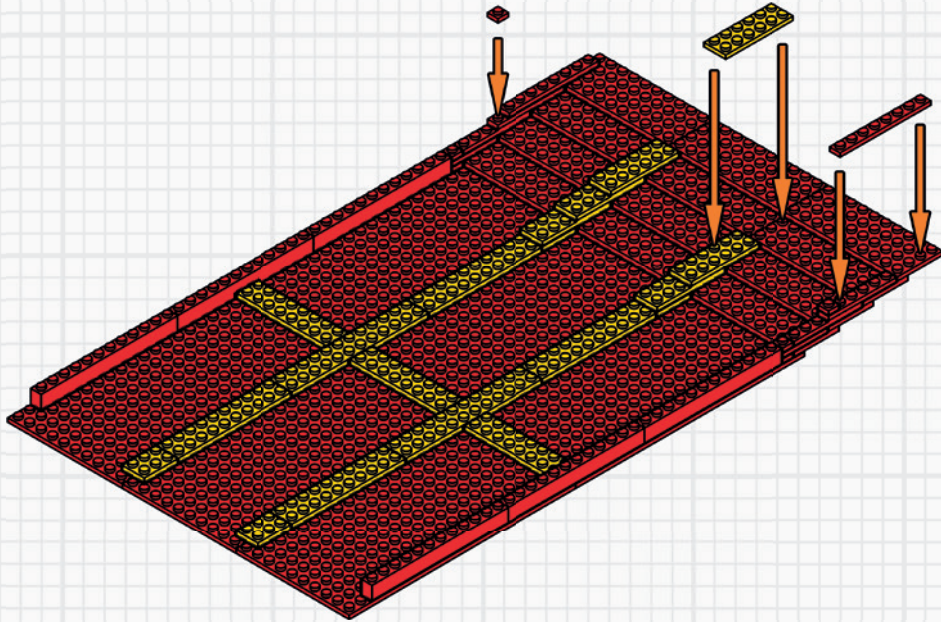
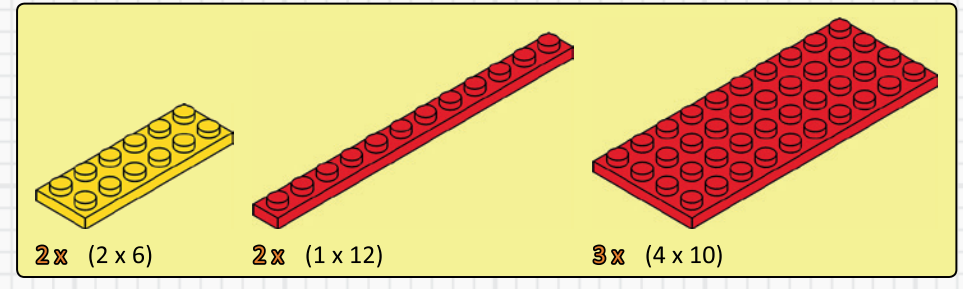
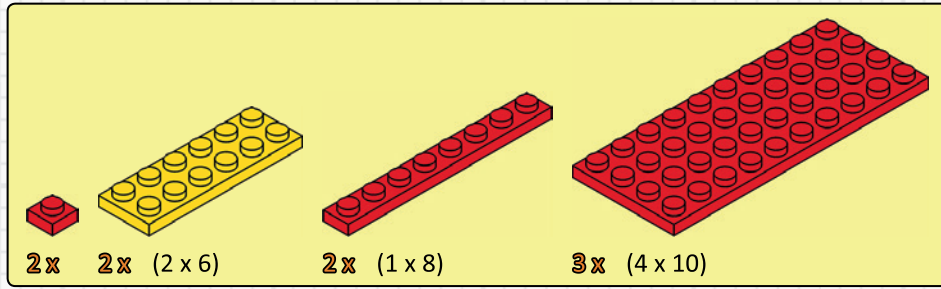



# Step 09



M38-70093



# Step 10

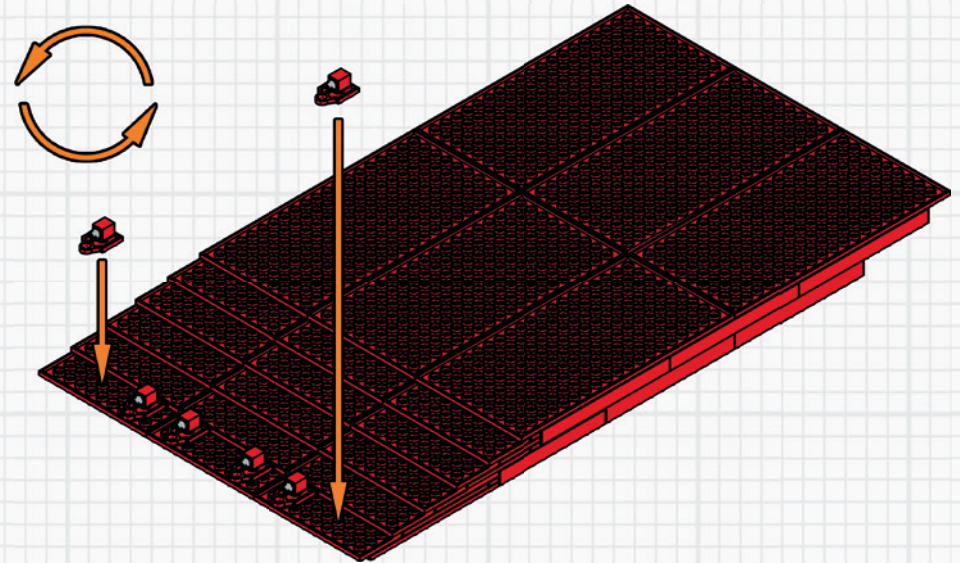
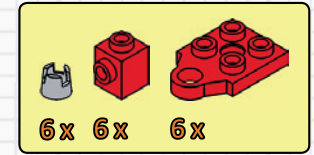
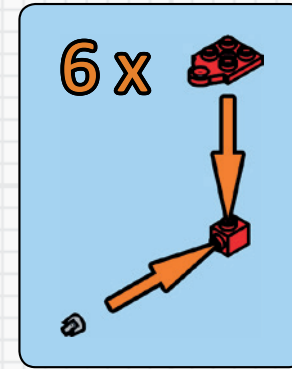
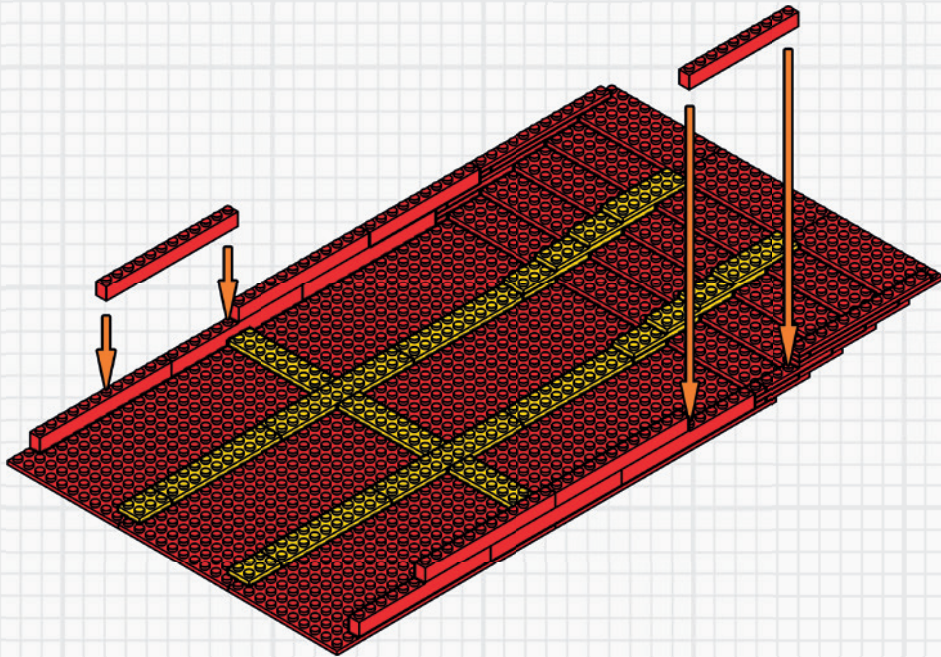
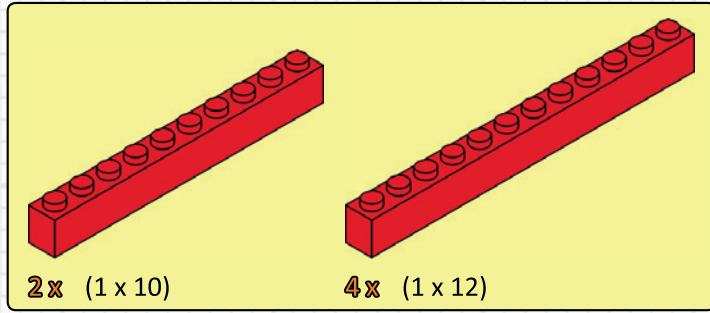



# Step 11



M38-70093



# Step 12

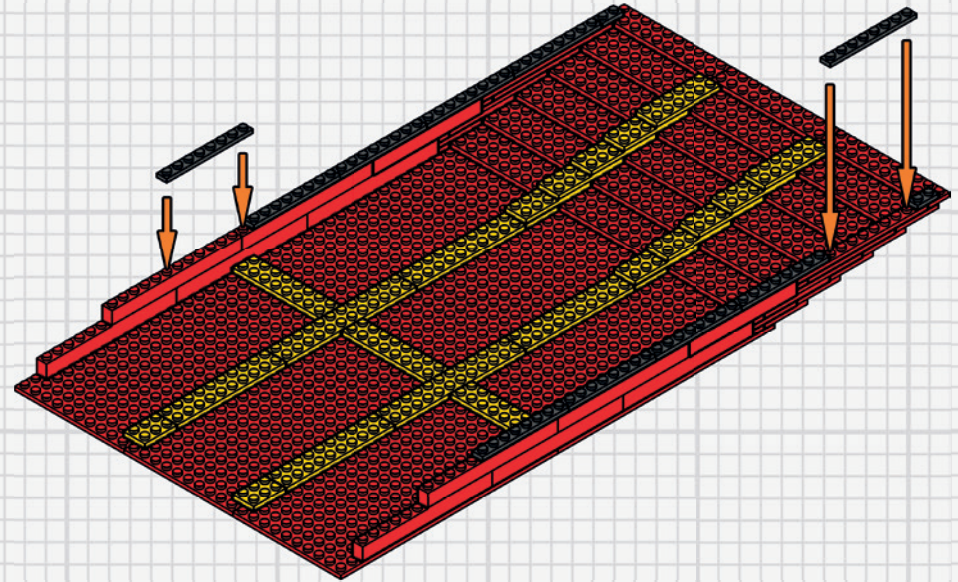
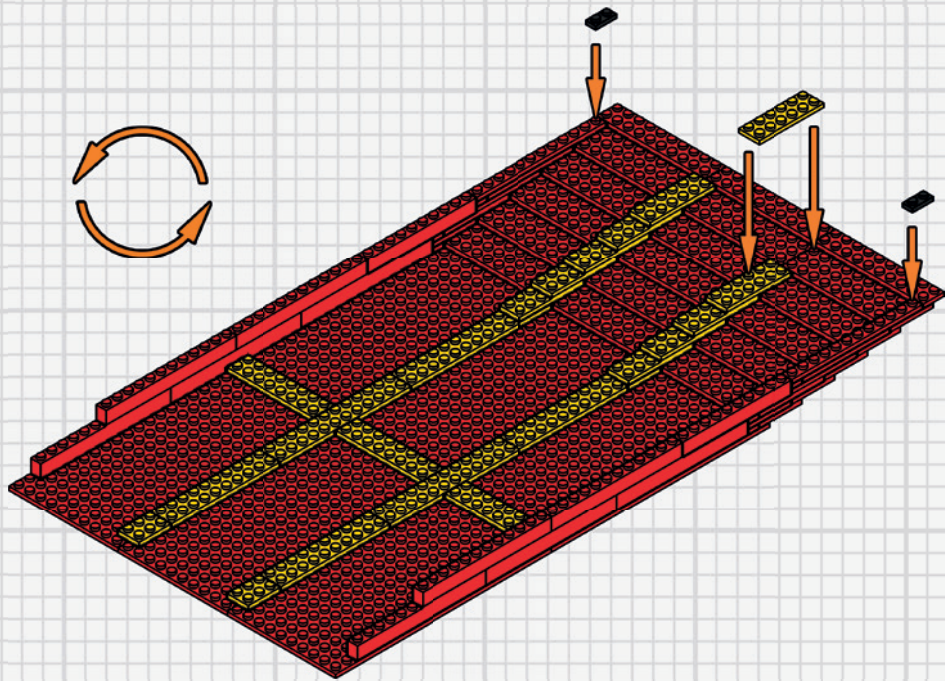
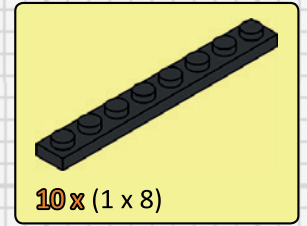
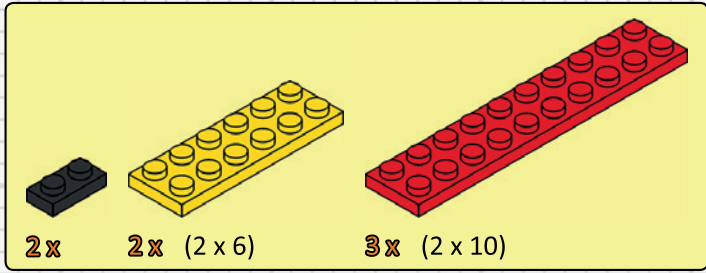



# Step 13



M38-70093



Iseas

# Step 14

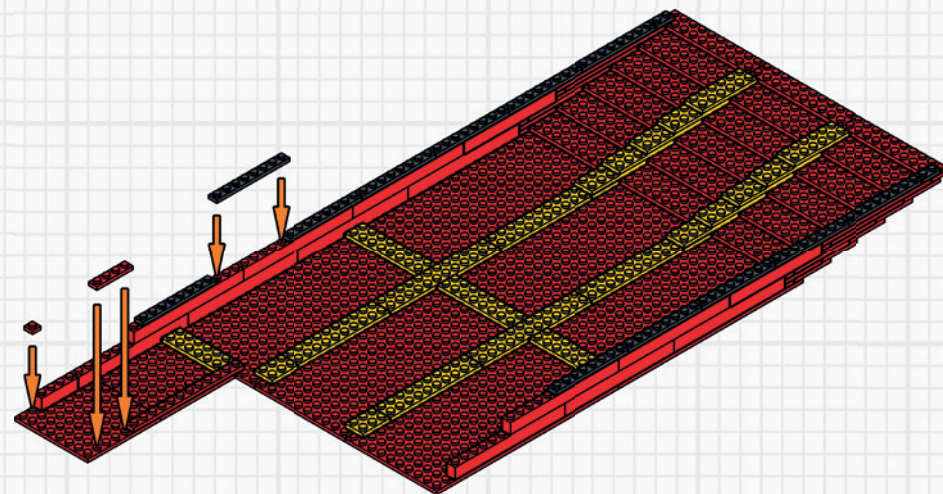
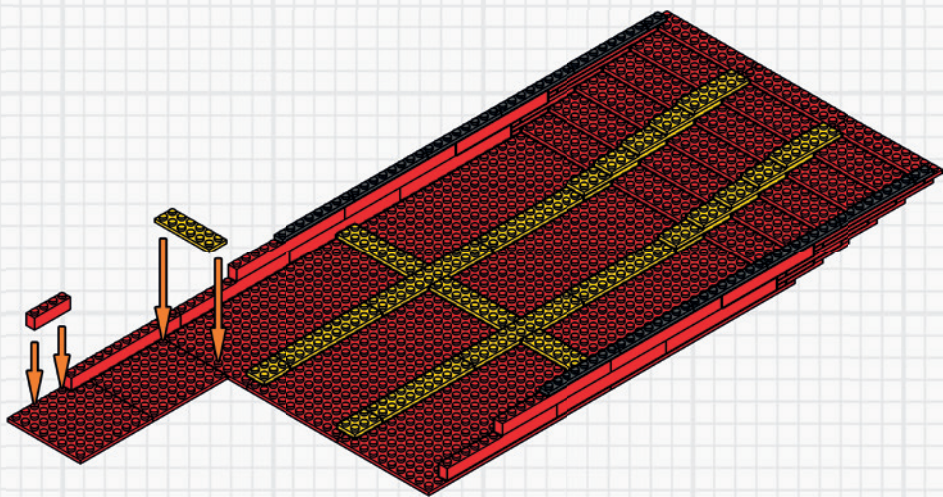
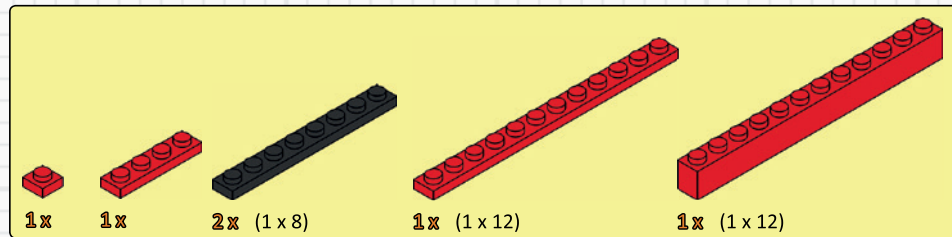
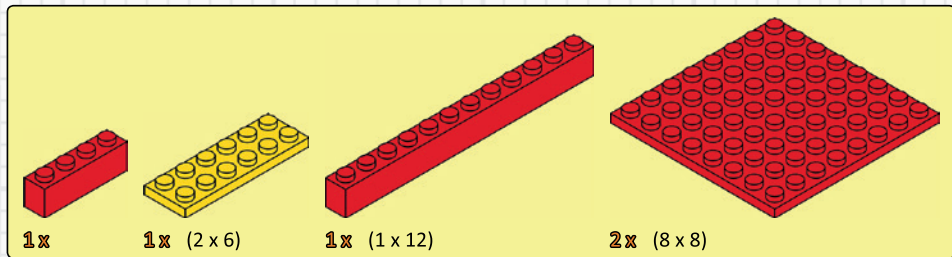



# Step 15



M38-70093



elseas

# Step 16

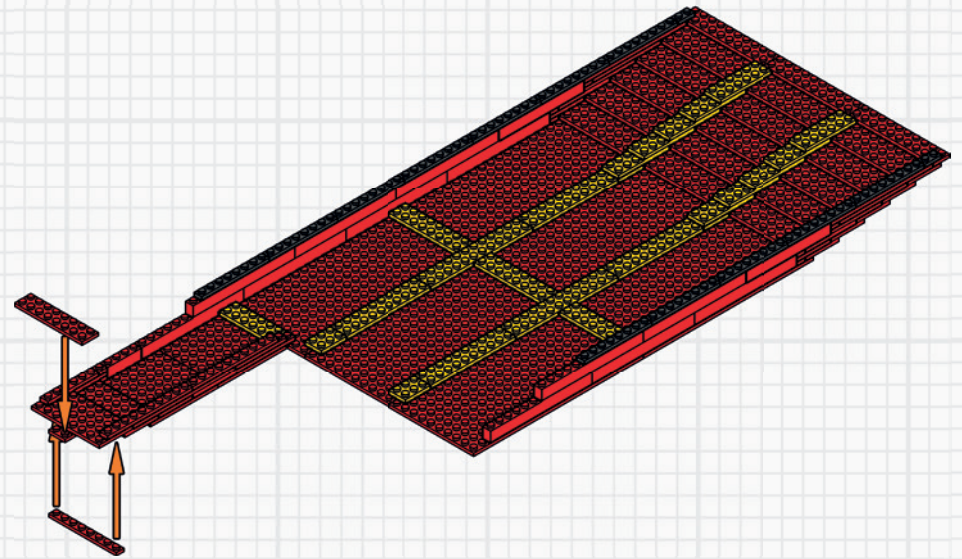
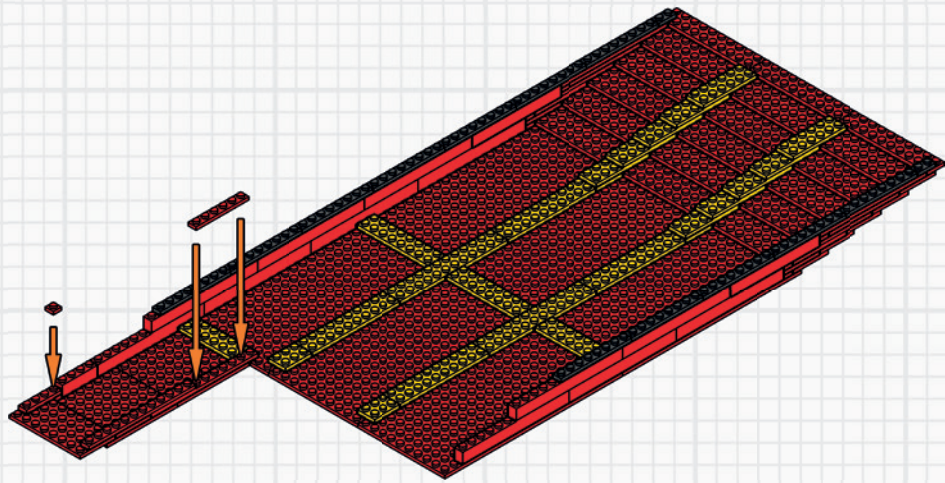
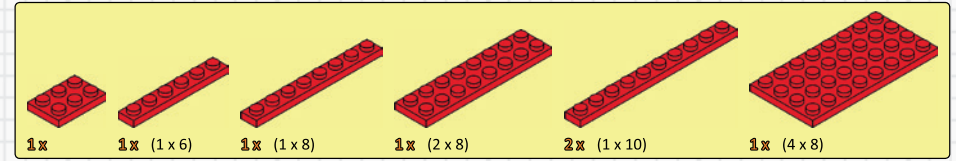
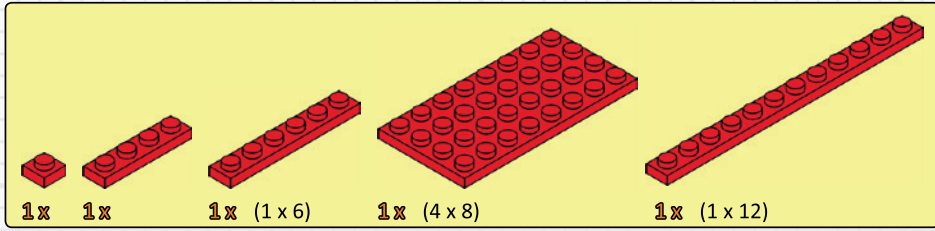



# Step 17



M38-70093



Iseas

# Step 18

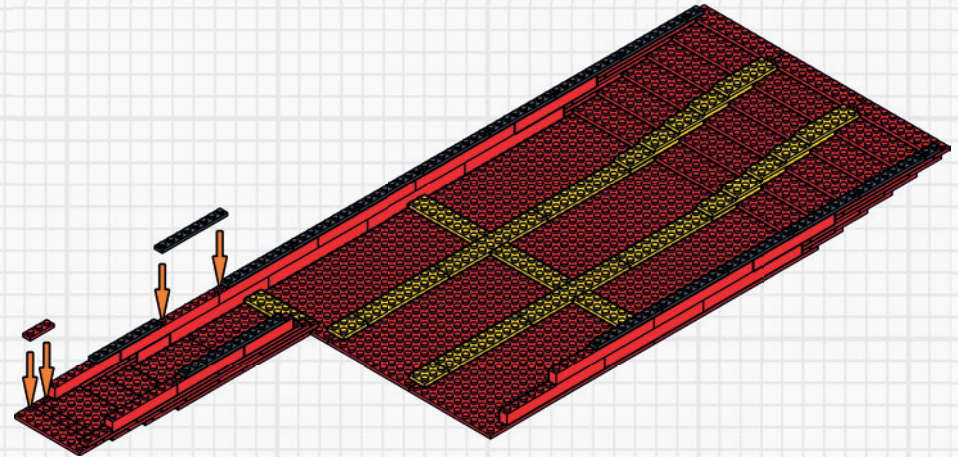
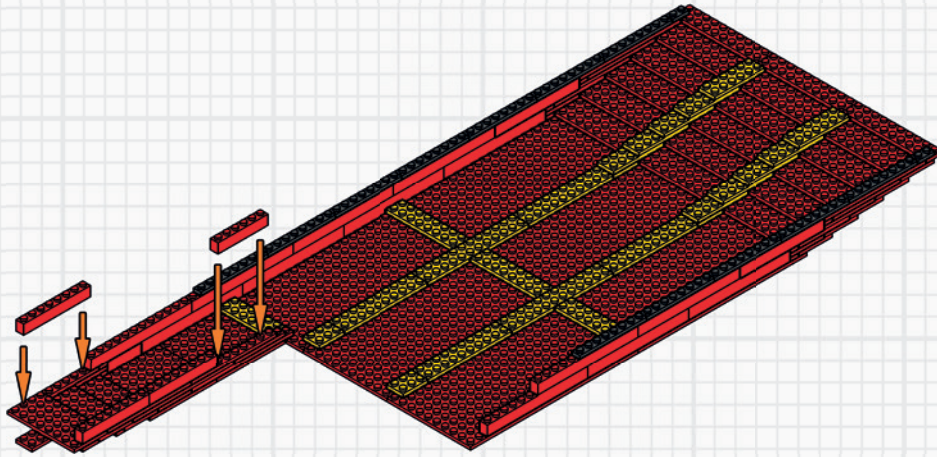
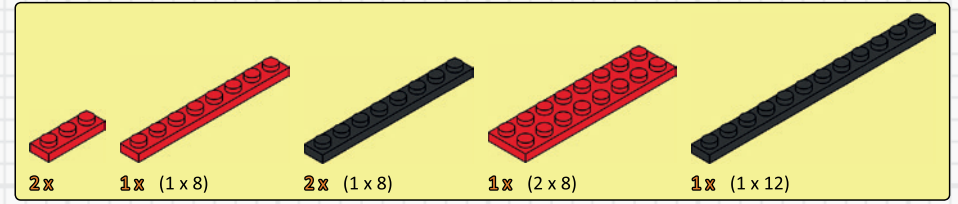
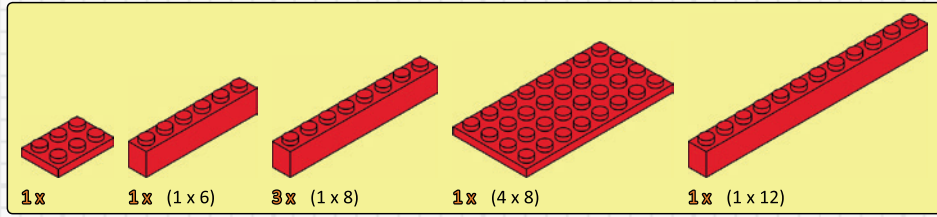



# Step 19



M38-70093



# Step 20

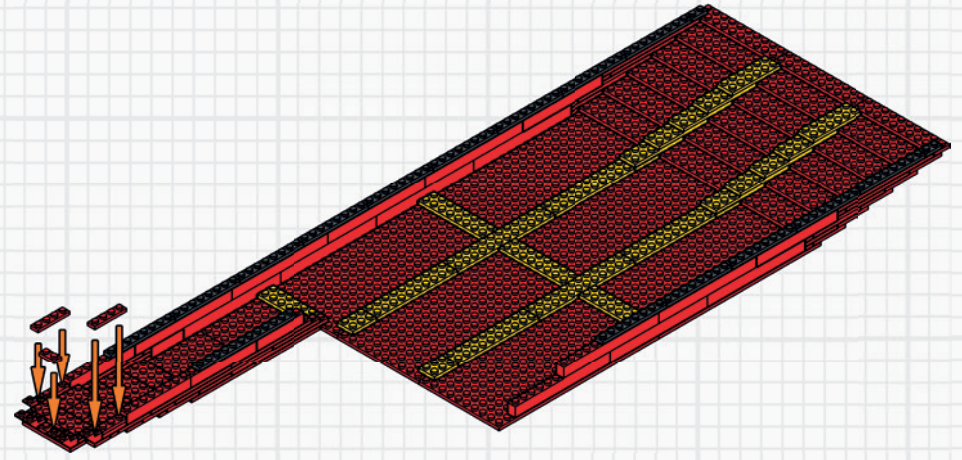
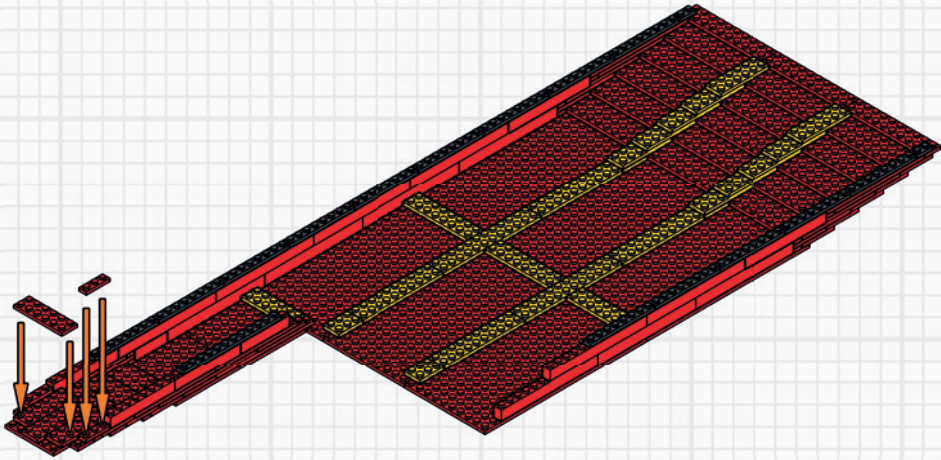
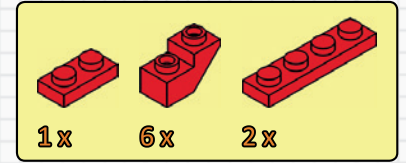
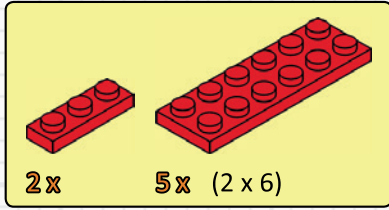



# Step 21



M38-70093



*elseas*

# Step 22

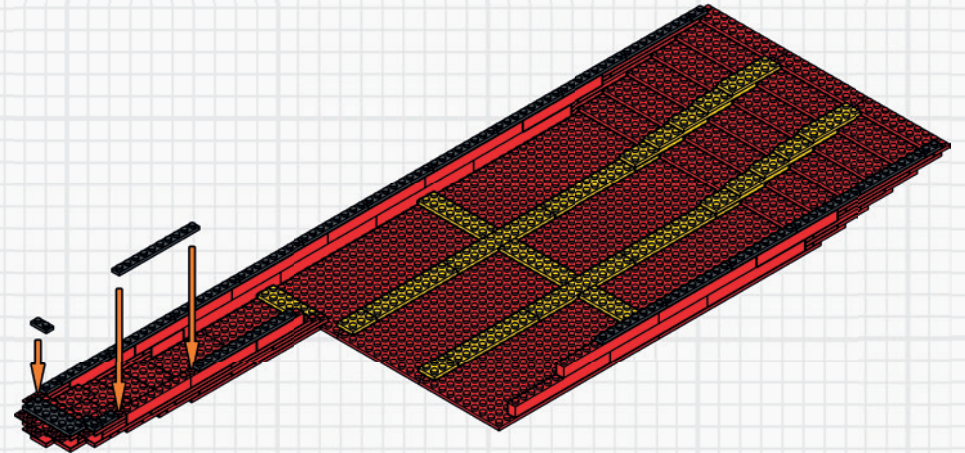
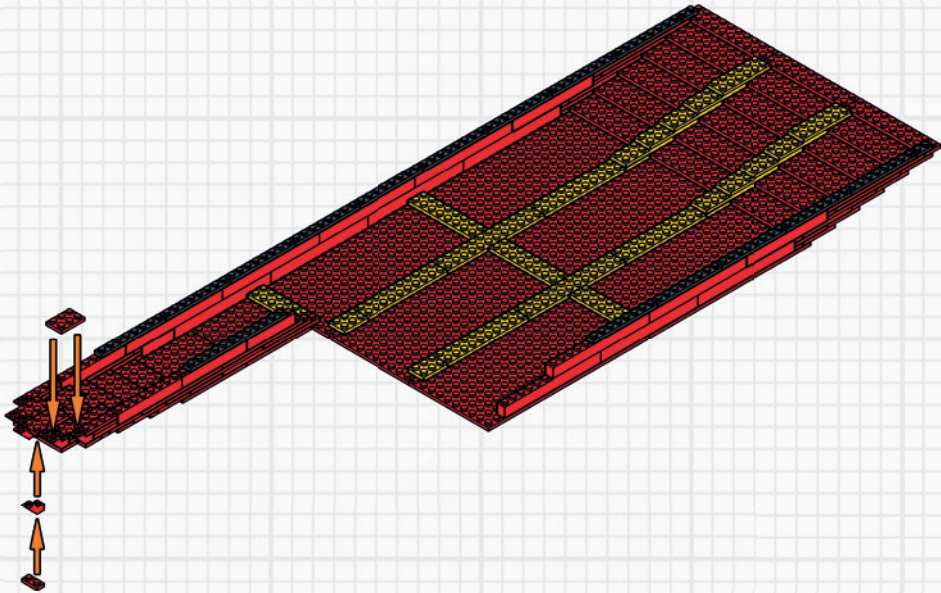
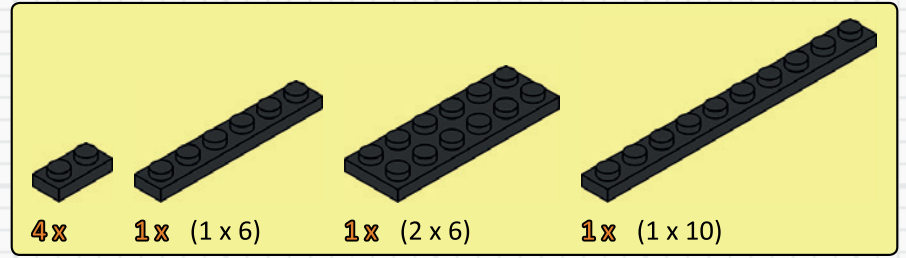
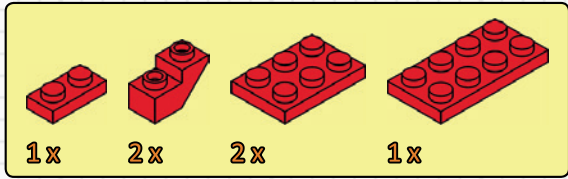



# Step 23



M38-70093



alseas

# Step 24

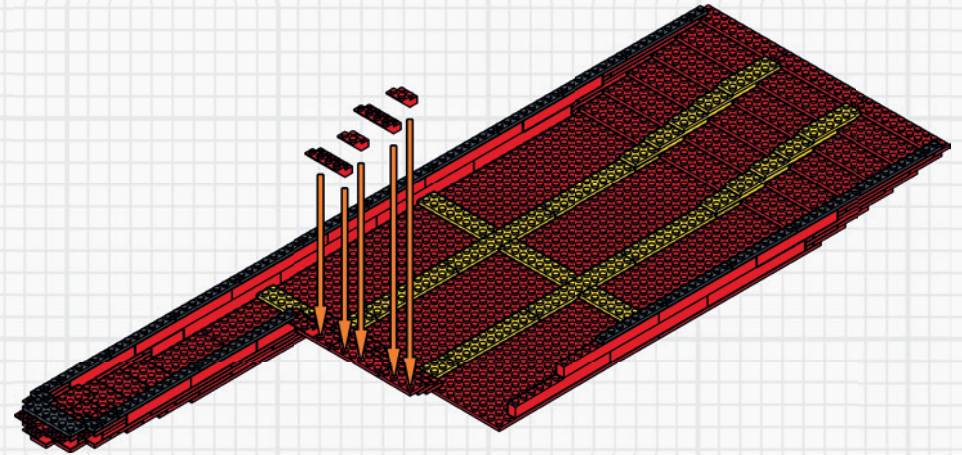
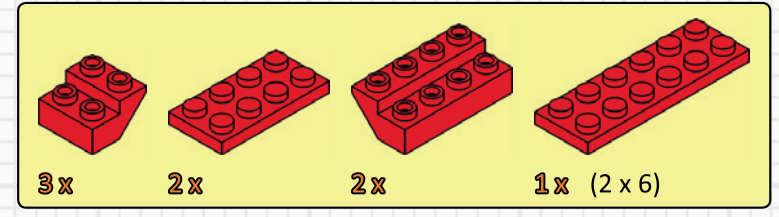
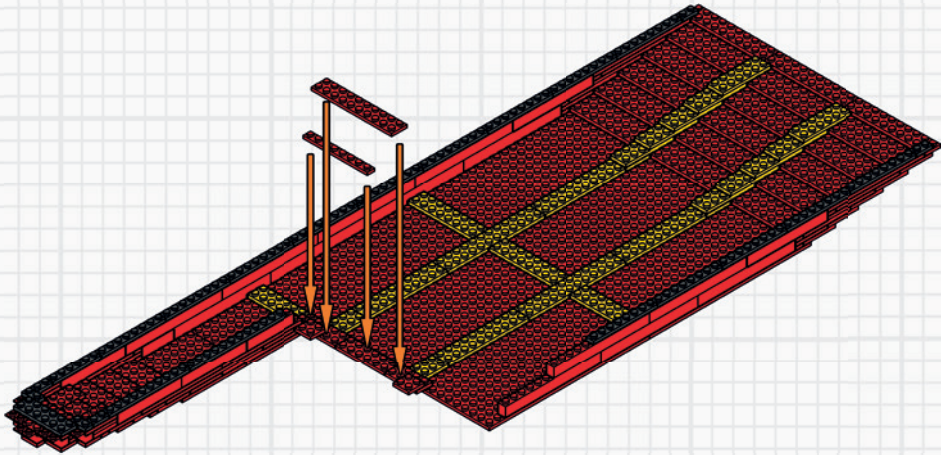
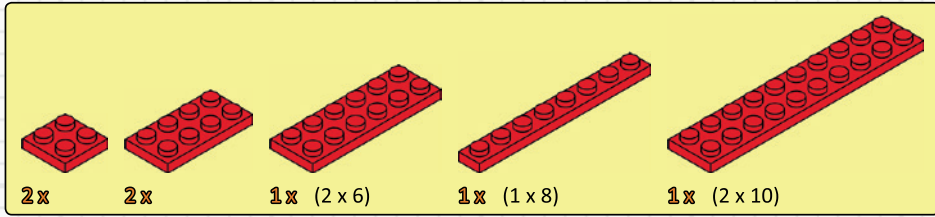



# Step 25



M38-70093



elseas

# Step 26

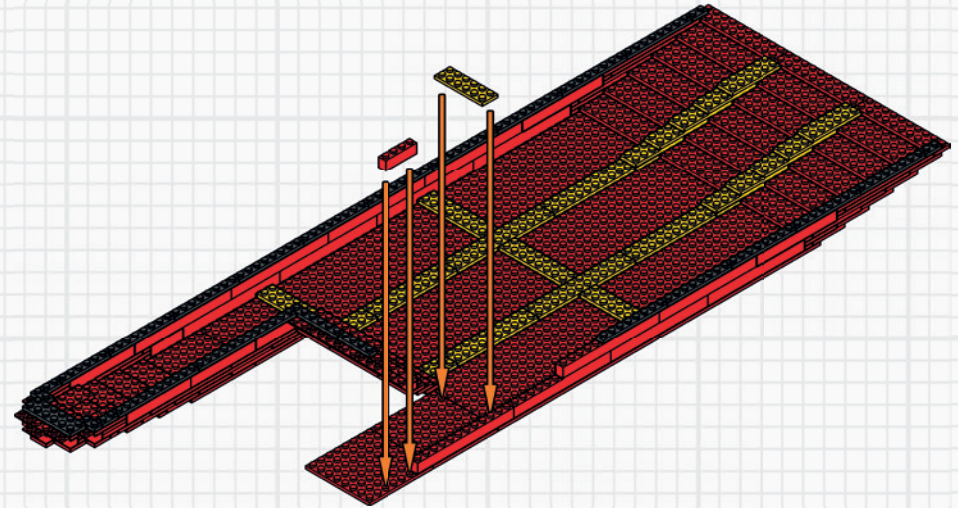
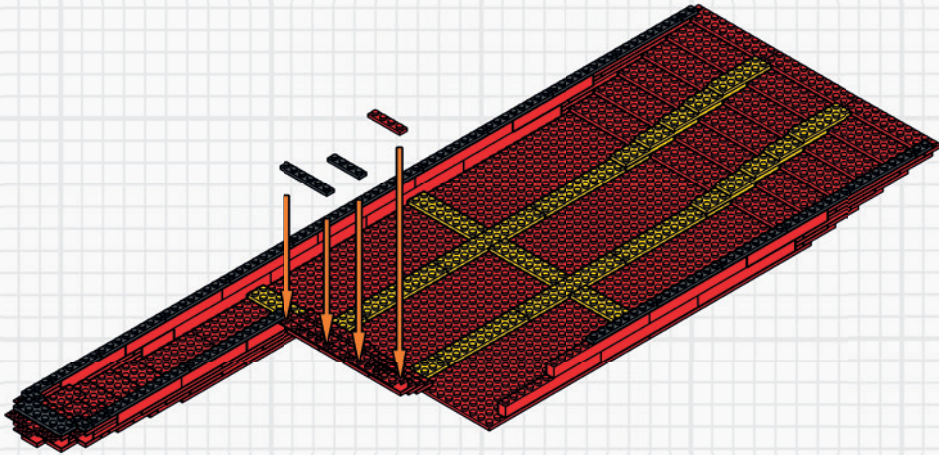
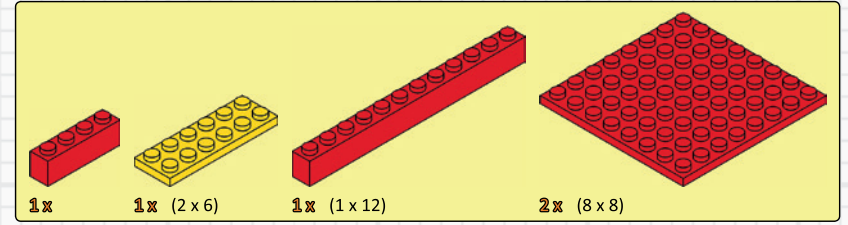
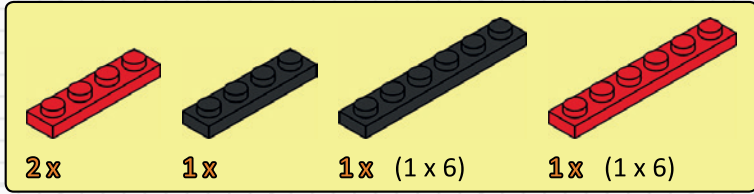



# Step 27



M38-70093



alseas

# Step 28

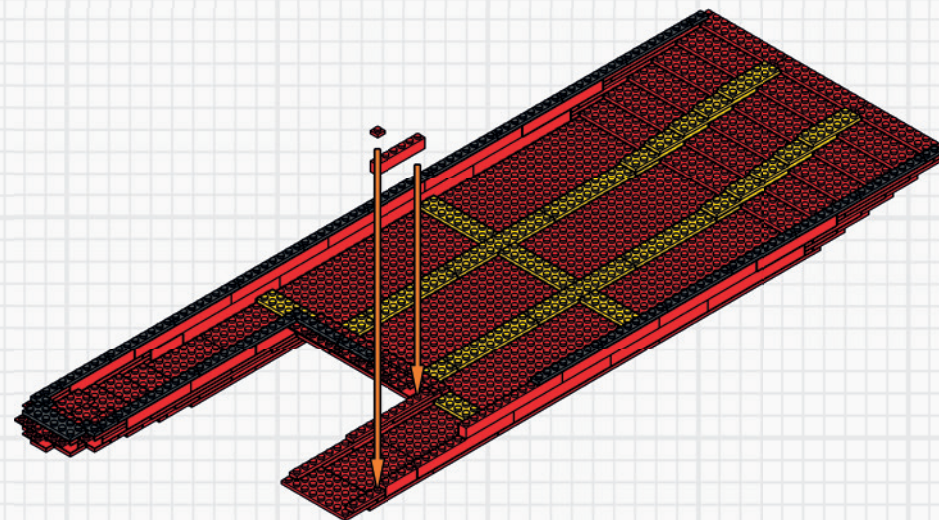
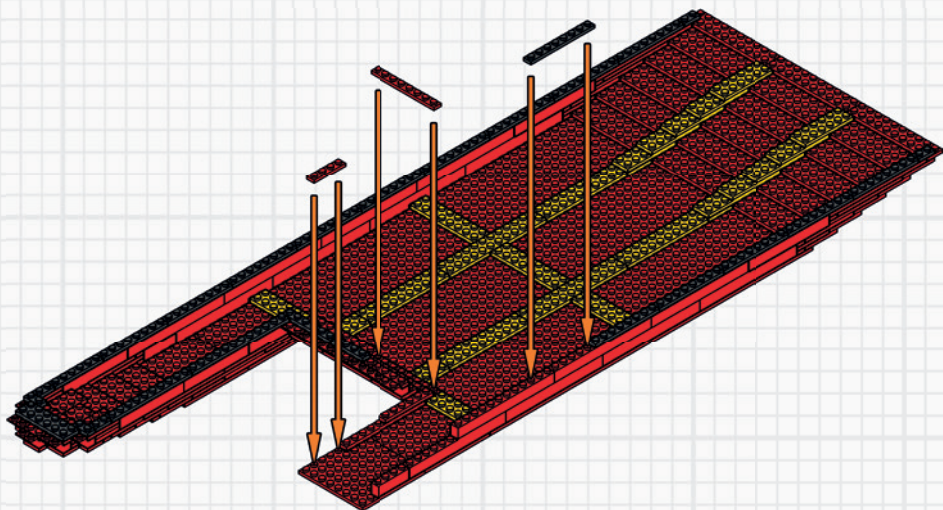
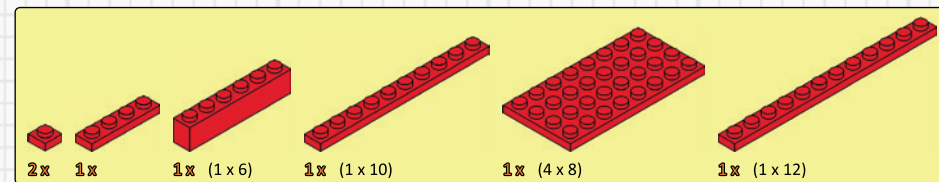
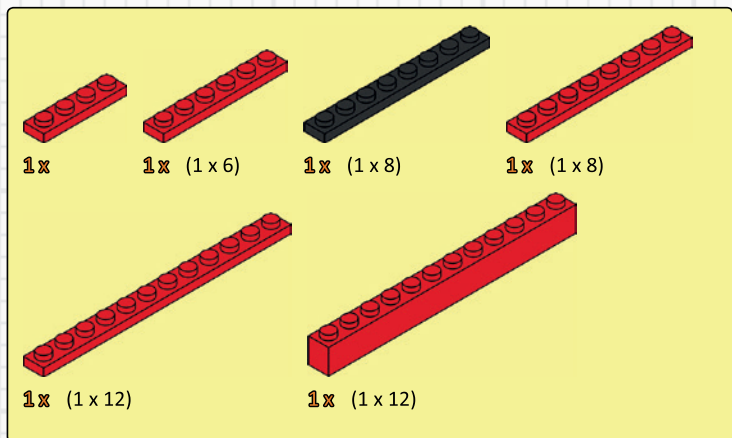



# Step 29



M38-70093



elseas

# Step 30

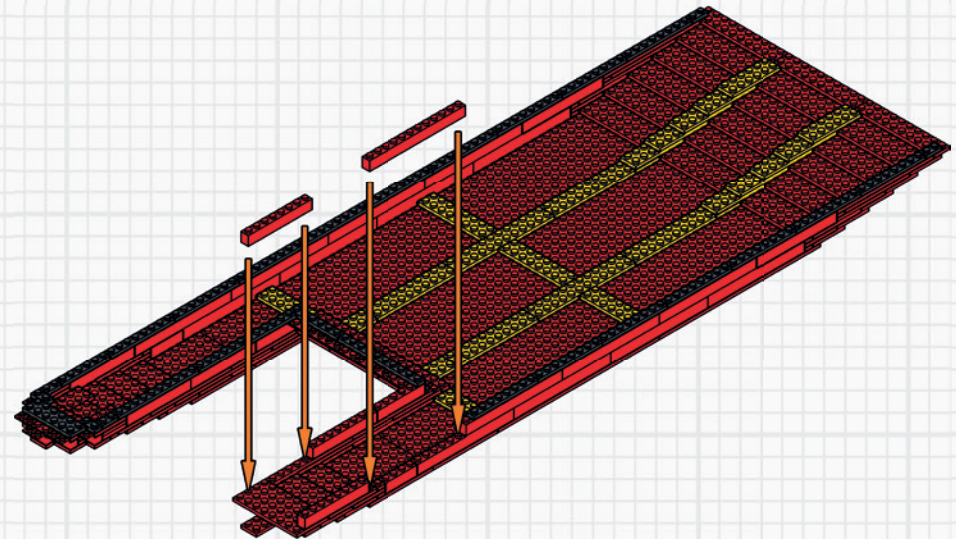
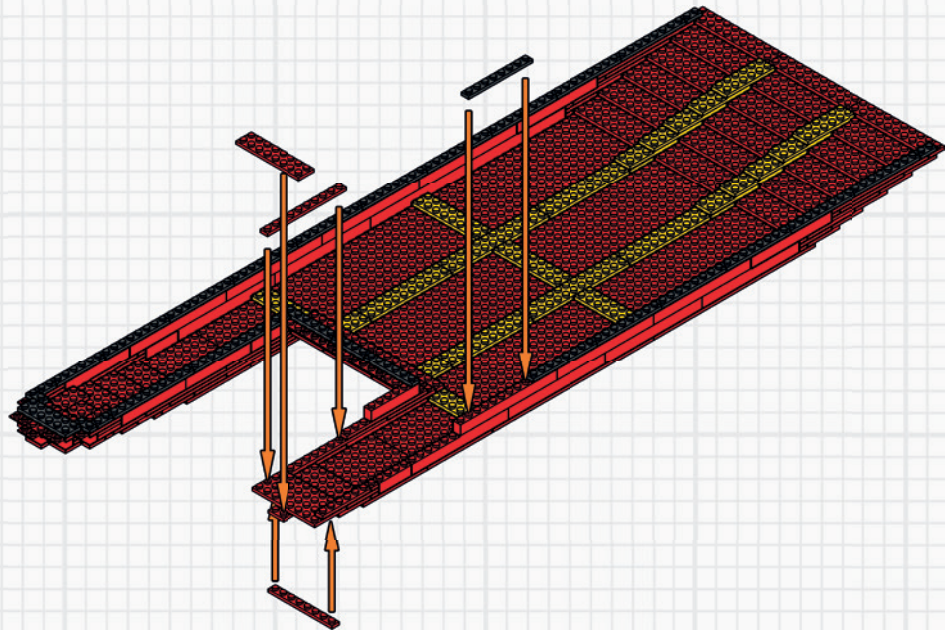
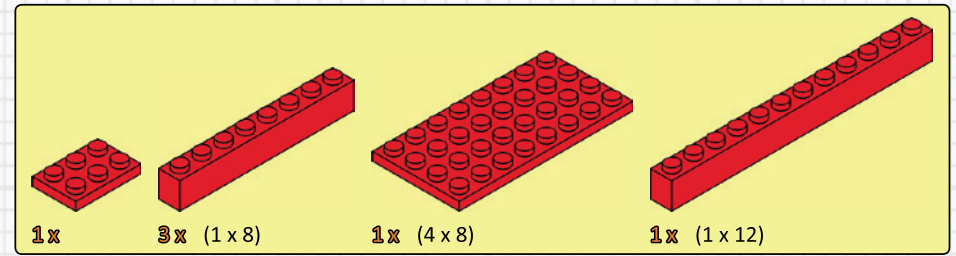
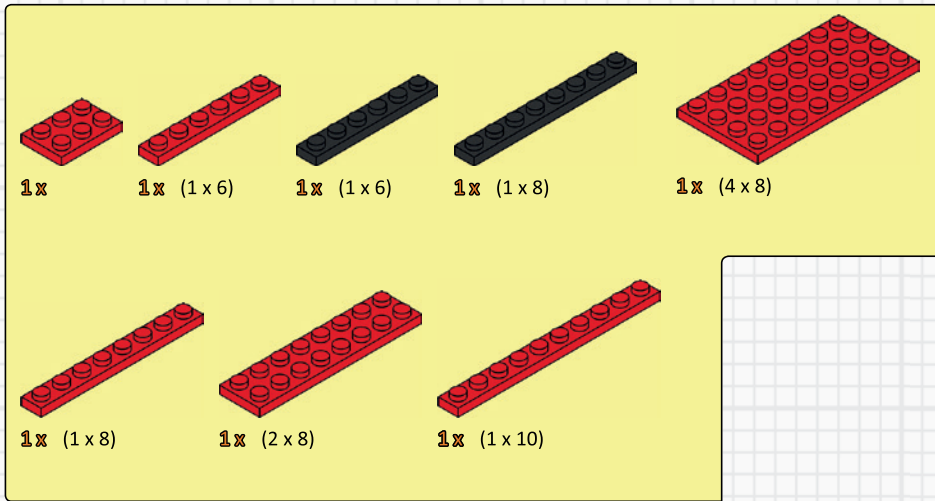



# Step 31



M38-70093



Alseas

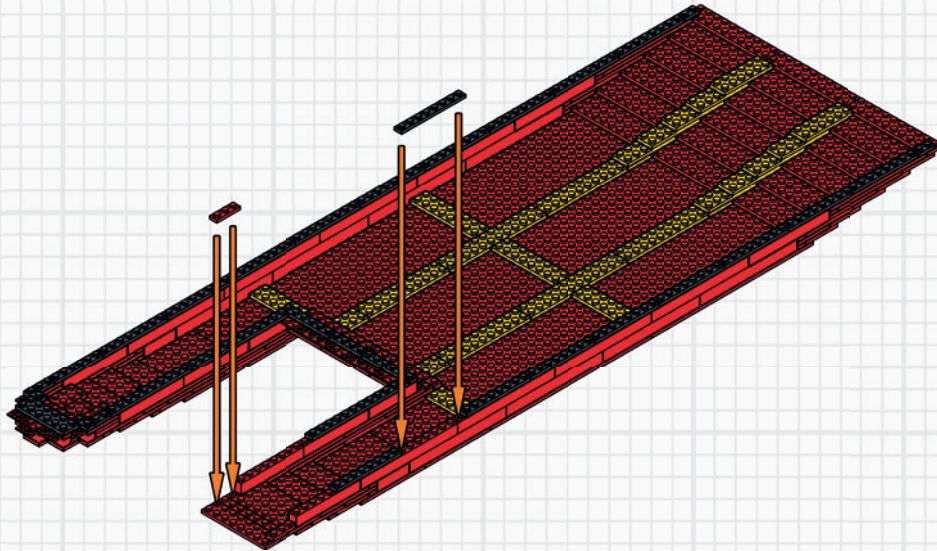
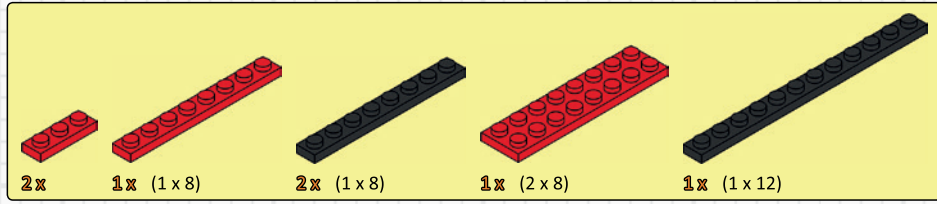

# Step 32

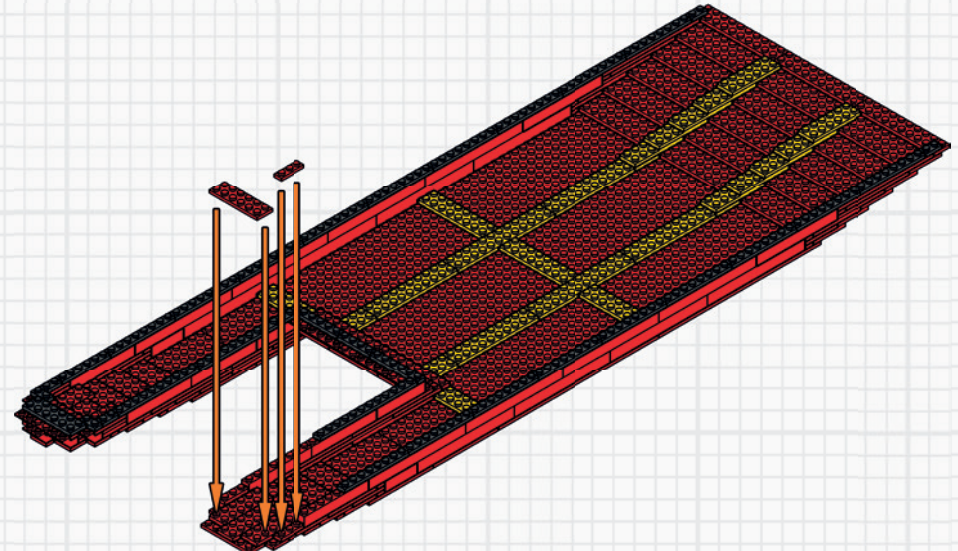
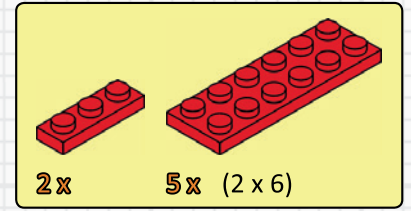

# Step 33



M38-70093



# Step 34

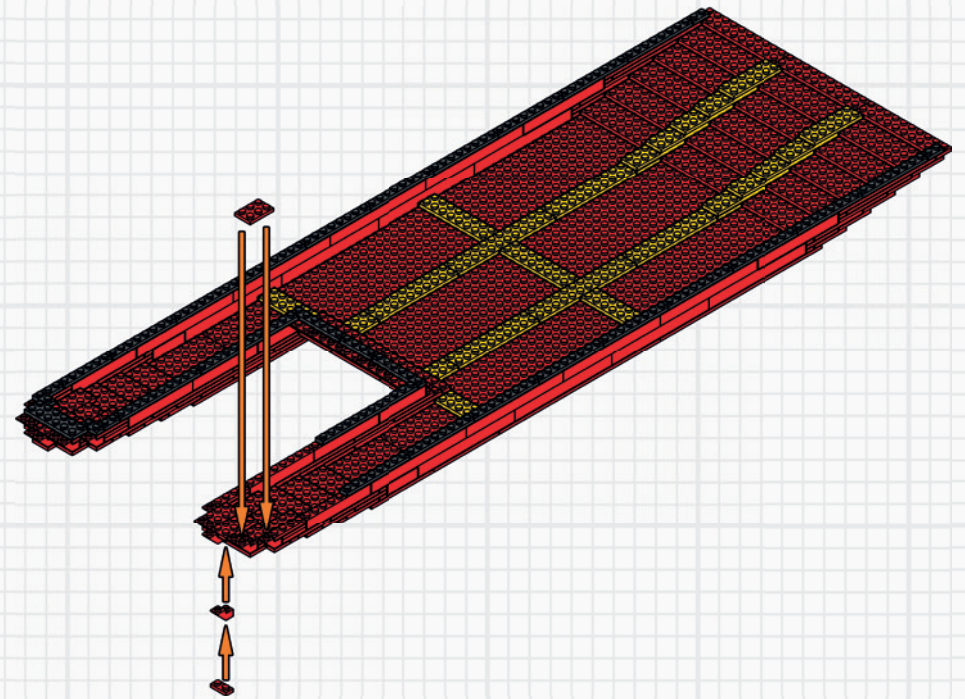
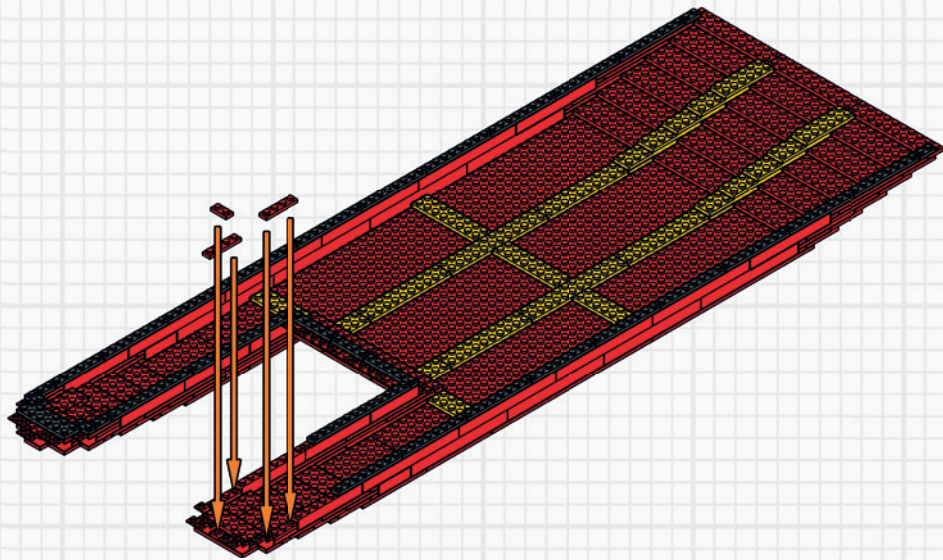
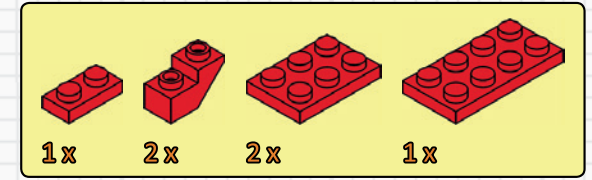
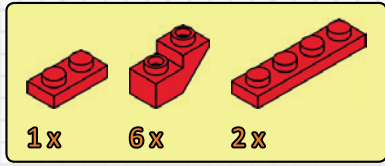



# Step 35



M38-70093



# Step 36

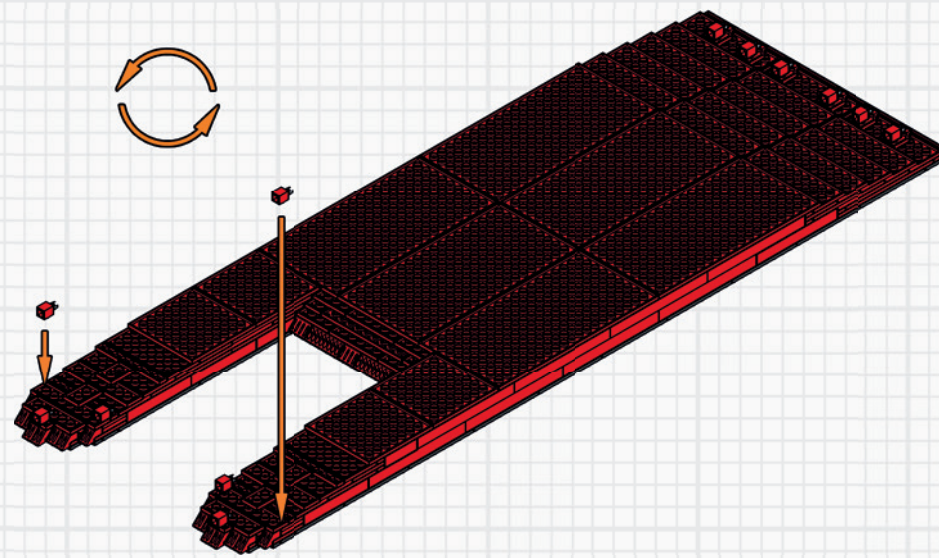
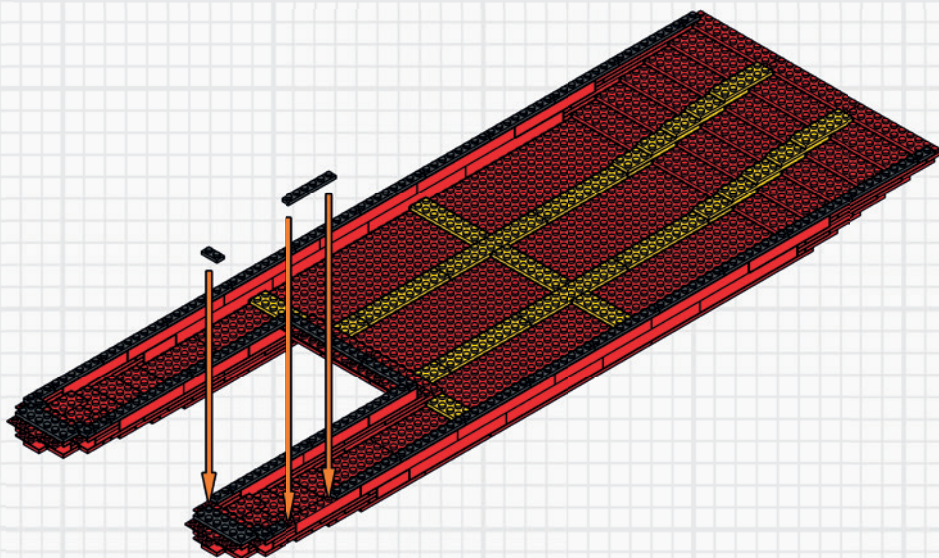
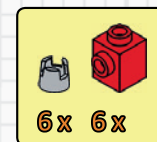
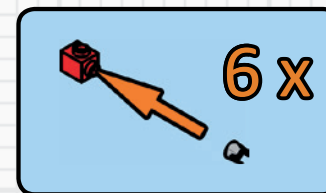
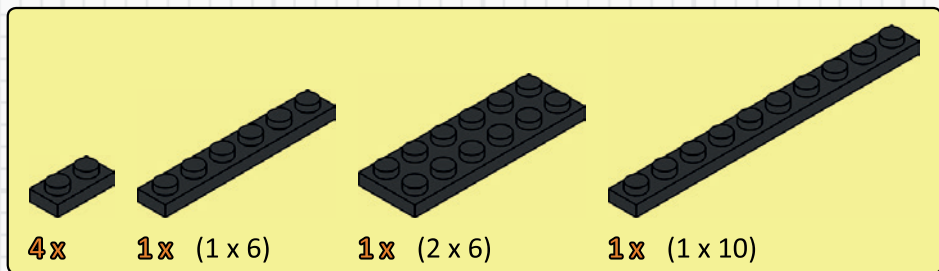

# Step 37



M38-70093

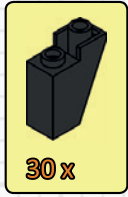

30 x

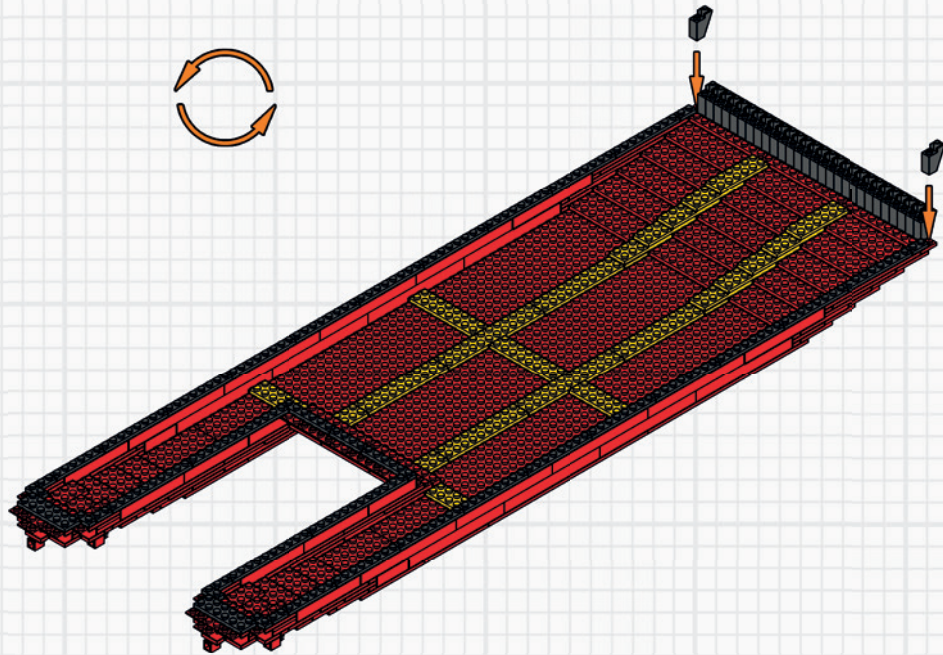

# Step 38

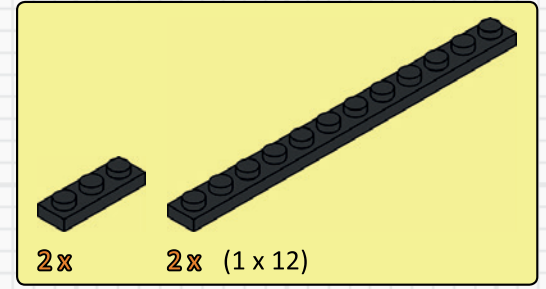

2 x

2 x (1 x 12)

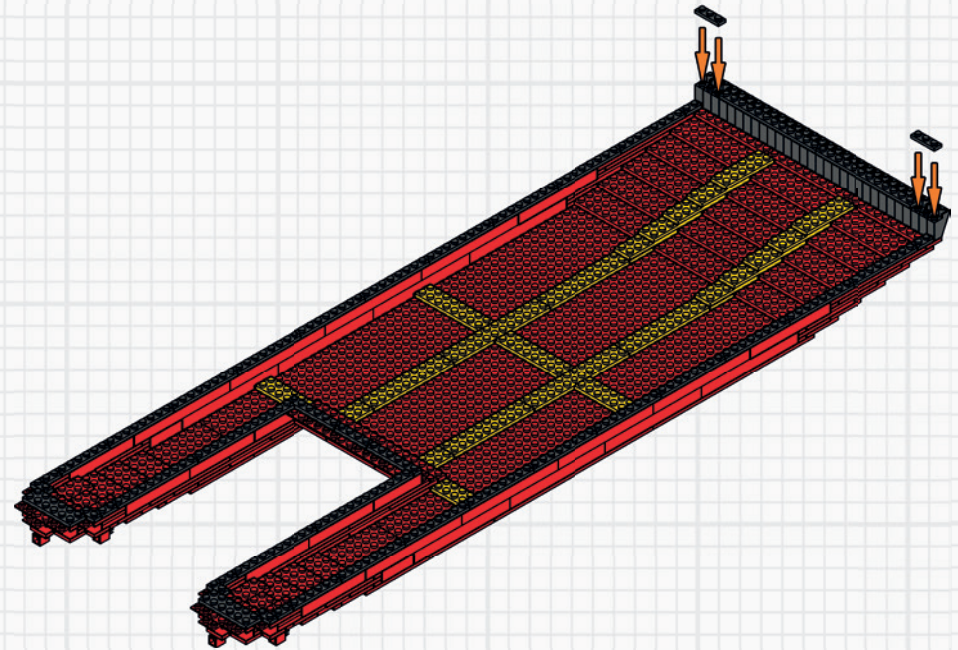



# Step 39



M38-70093



# Step 40

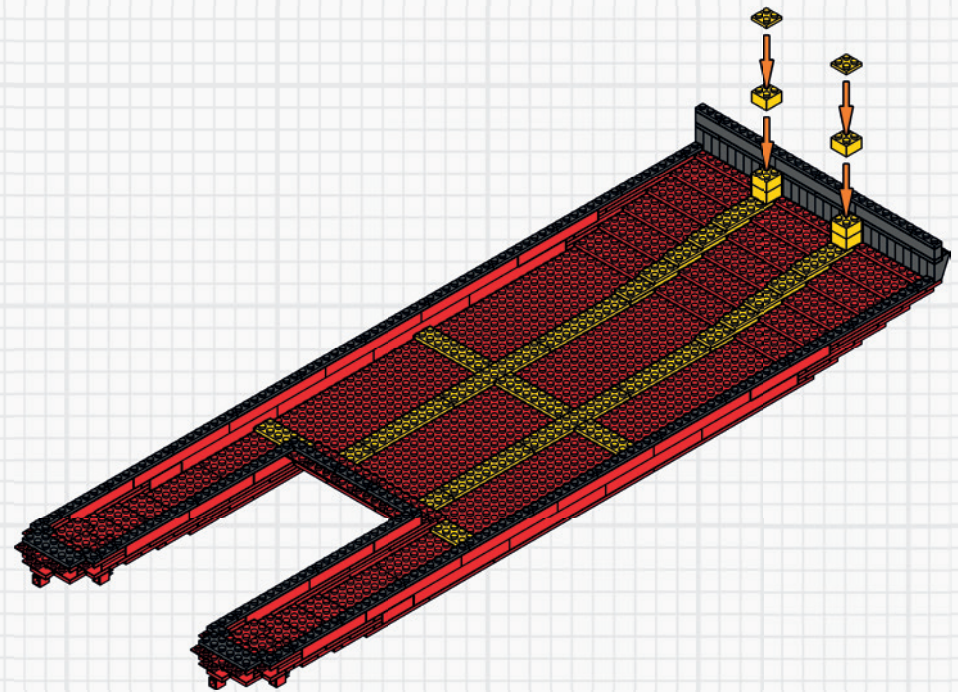
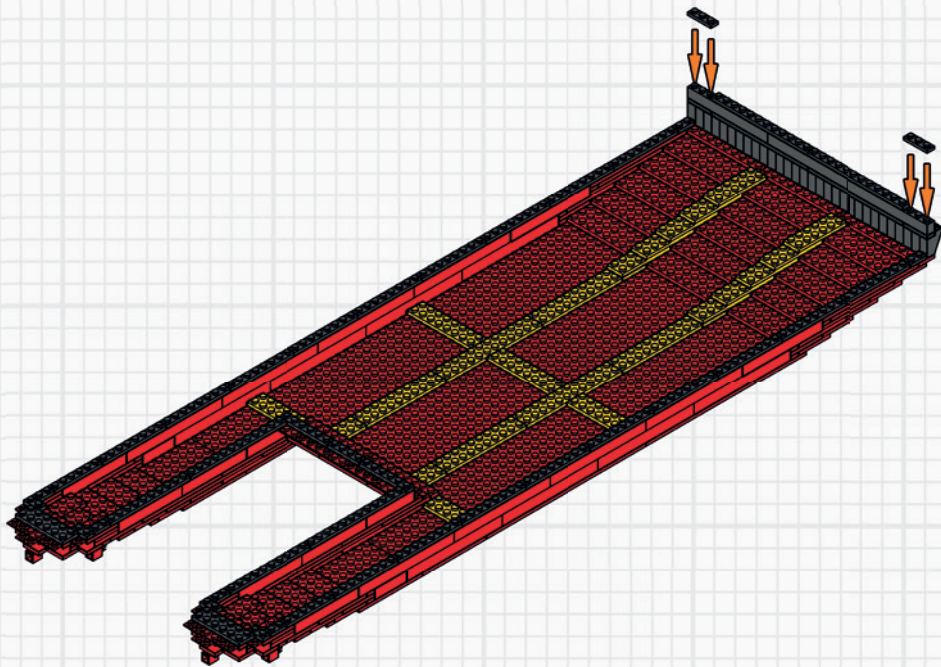
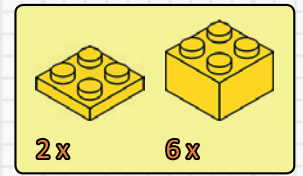
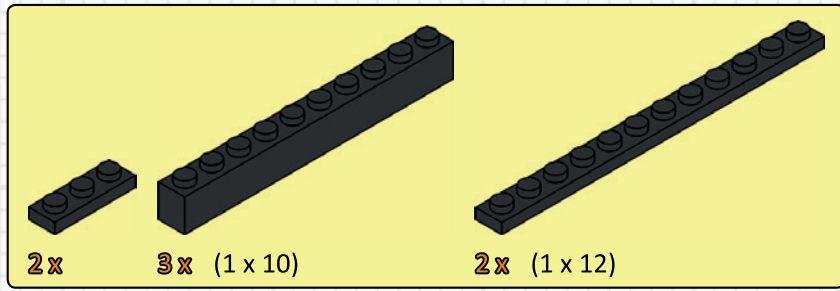

# Step 41



M38-70093



# Step 42

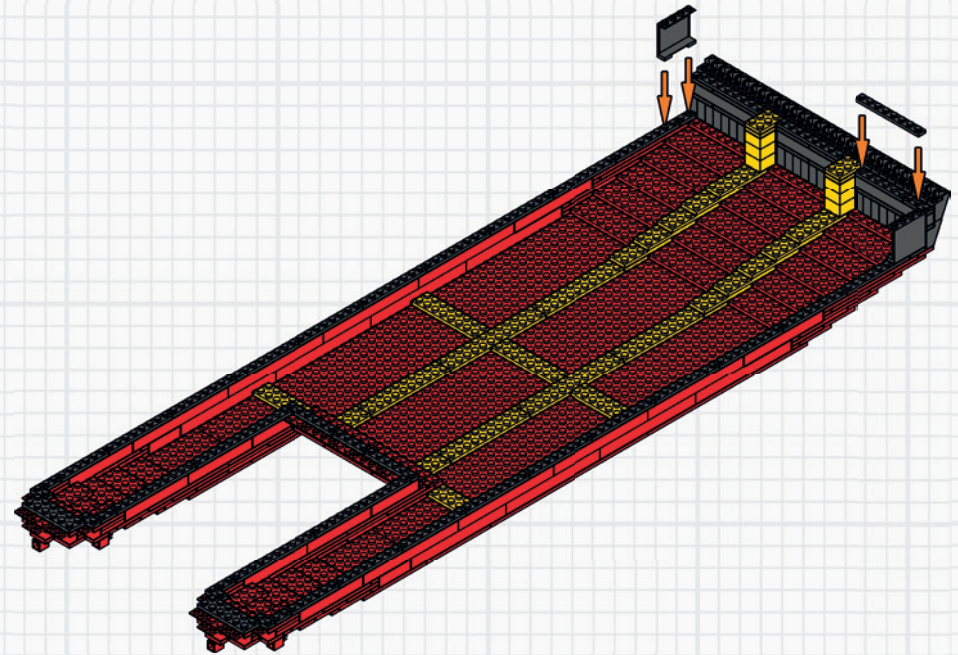
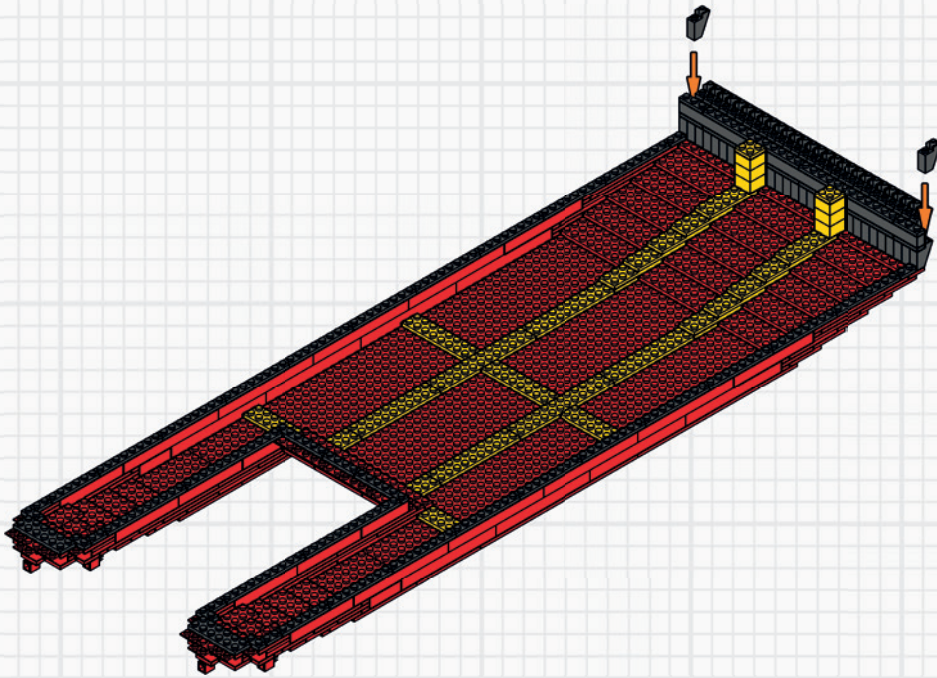
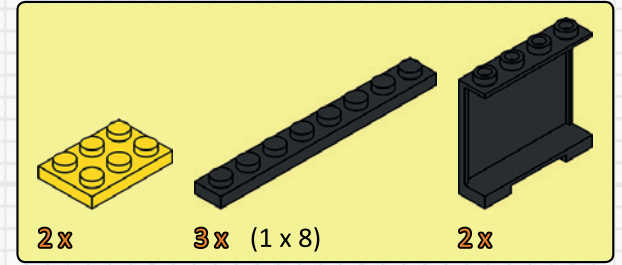
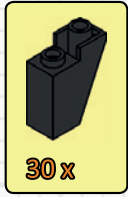



# Step 43



M38-70093

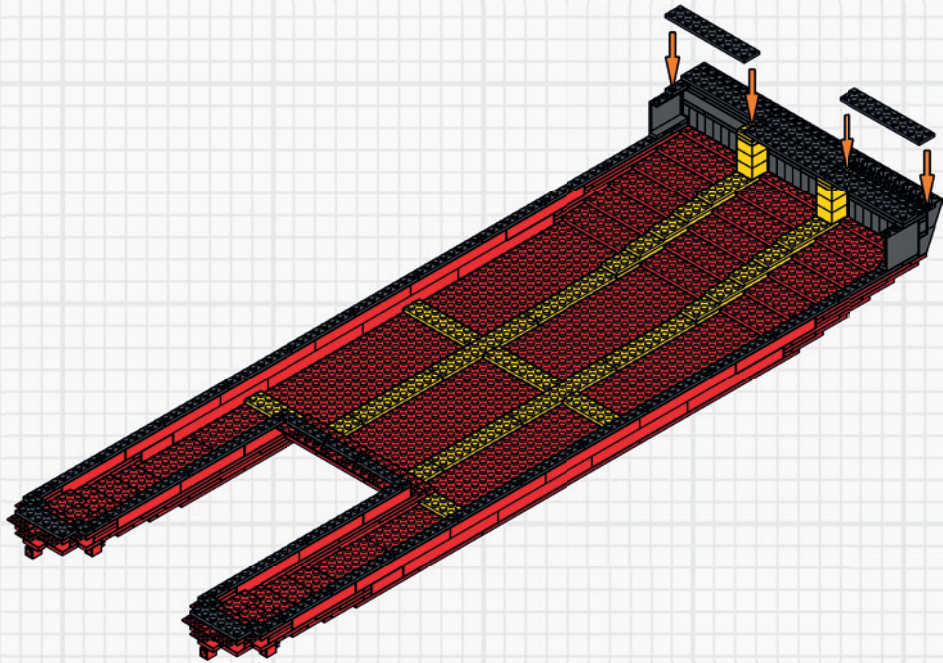
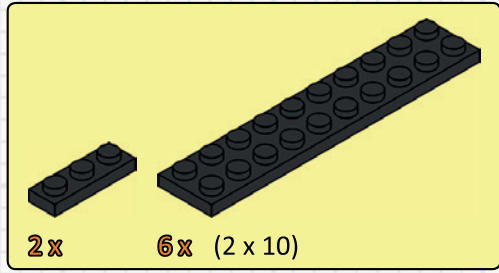

# Step 44

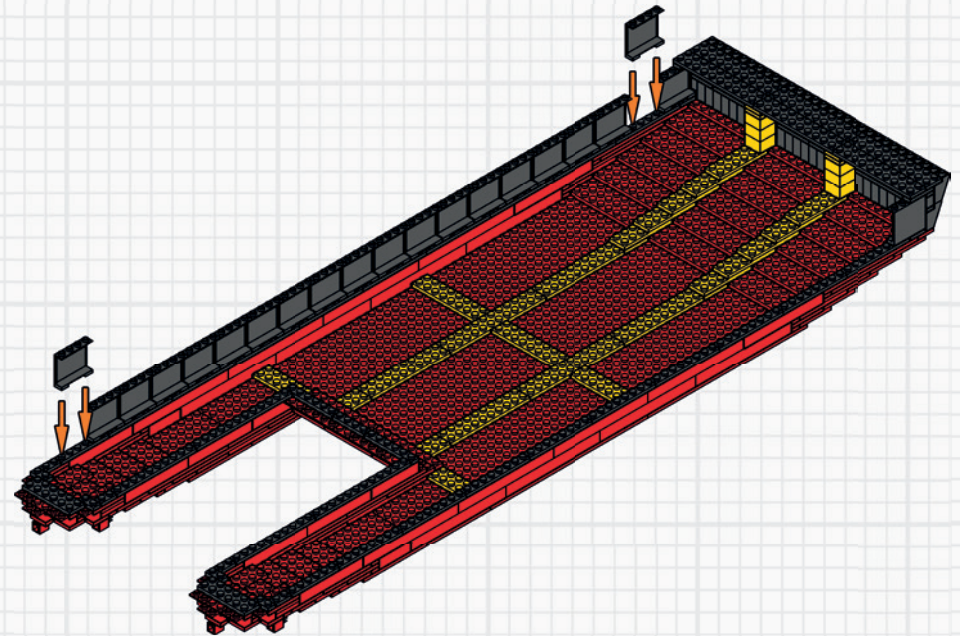
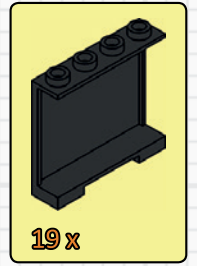

# Step 45



M38-70093



# Step 46

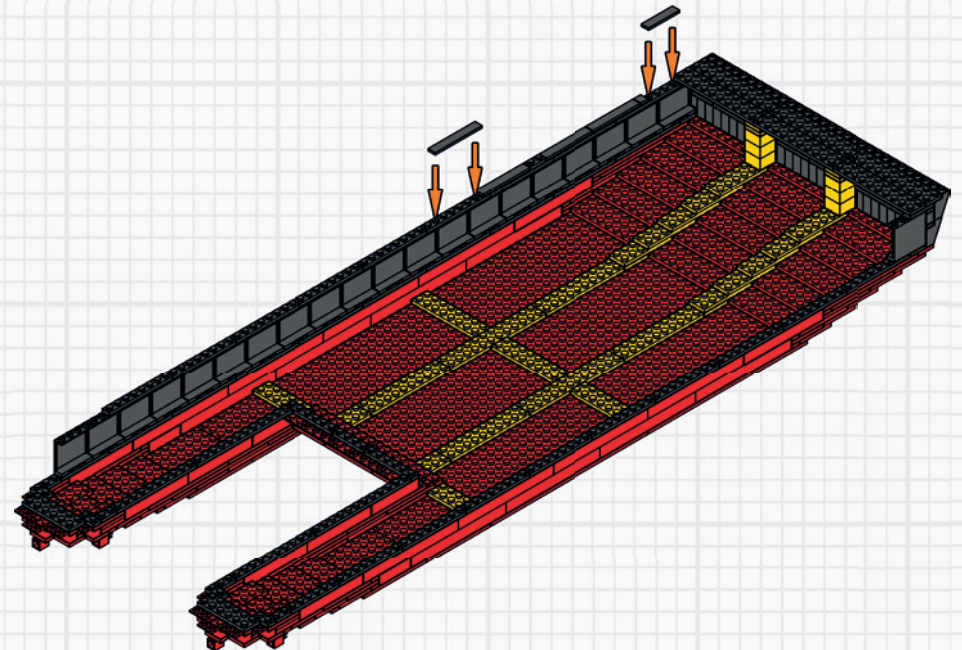
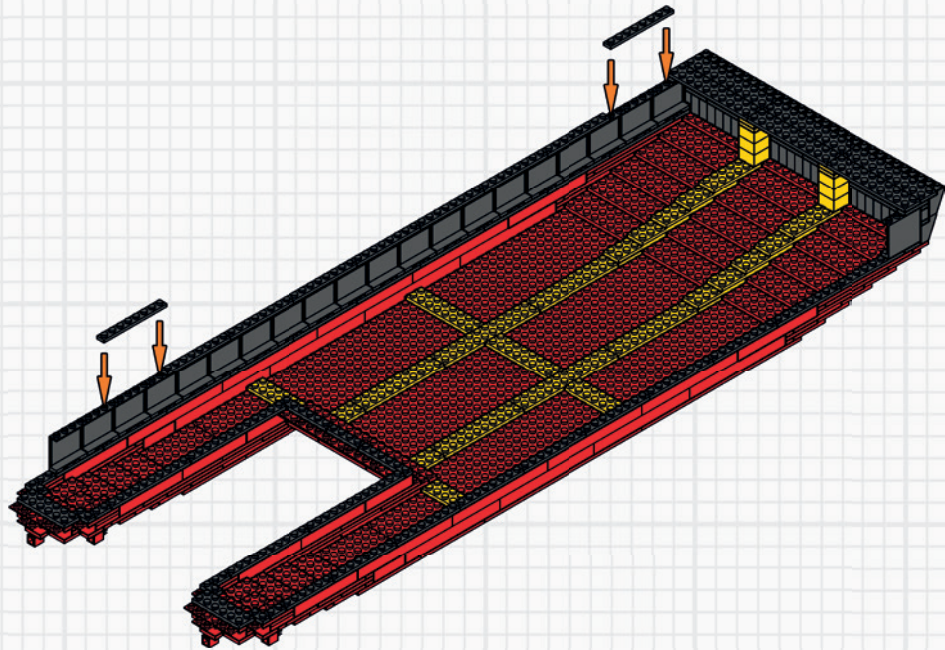
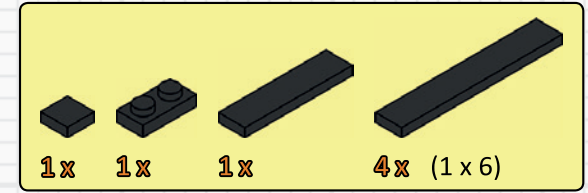
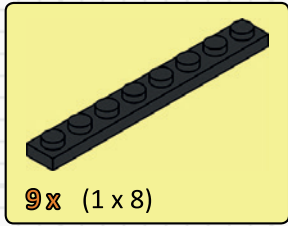



# Step 47



M38-70093



# Step 48

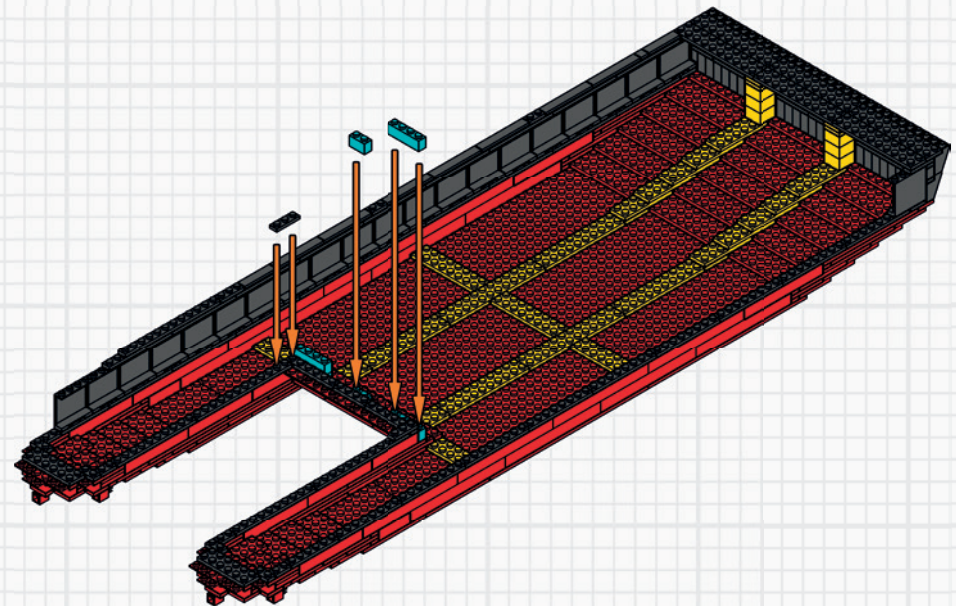
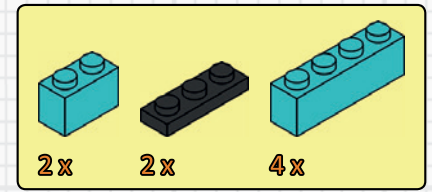
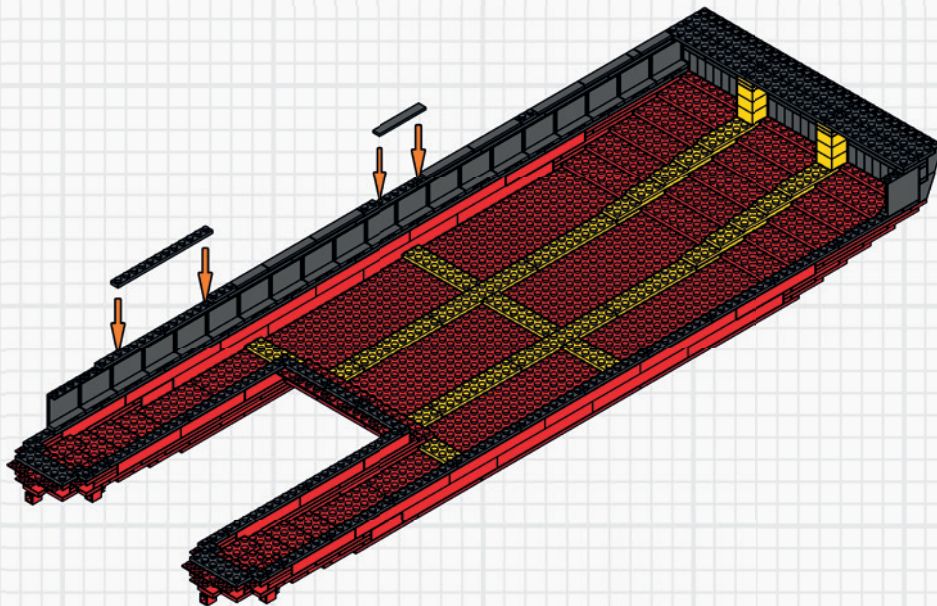
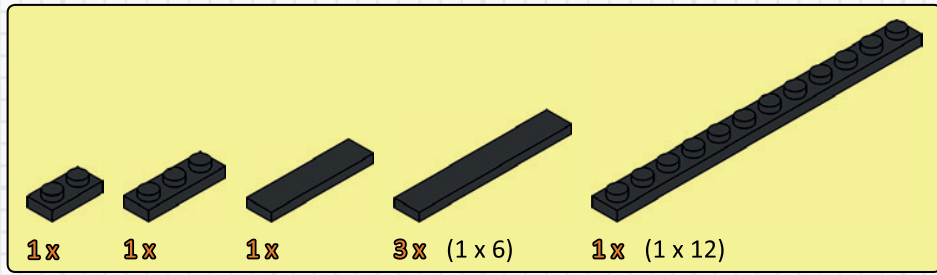

# Step 49



M38-70093



# Step 50

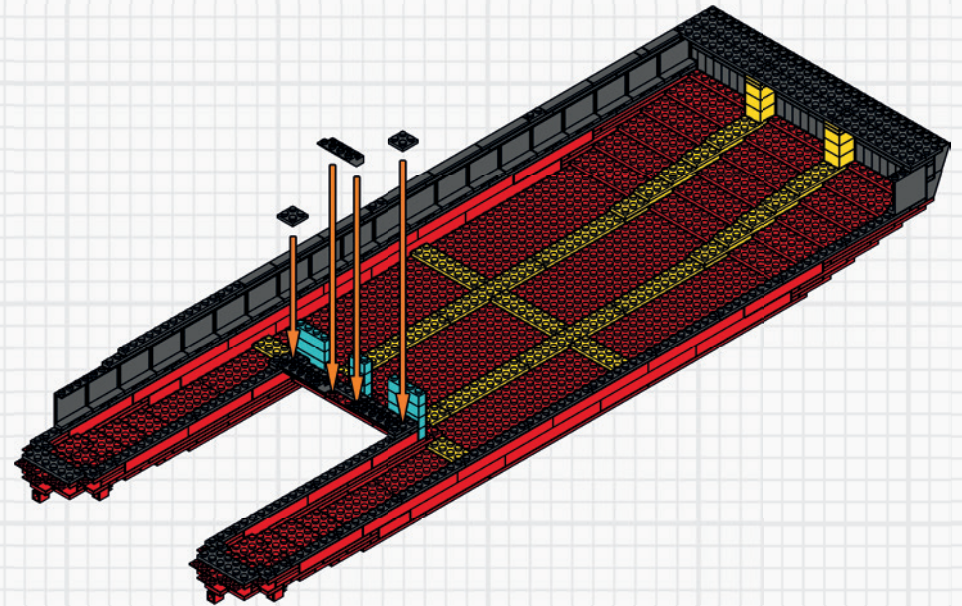
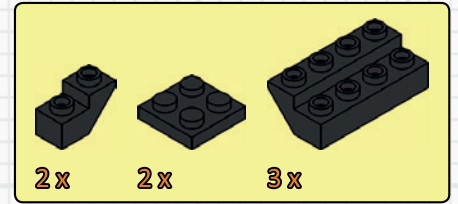
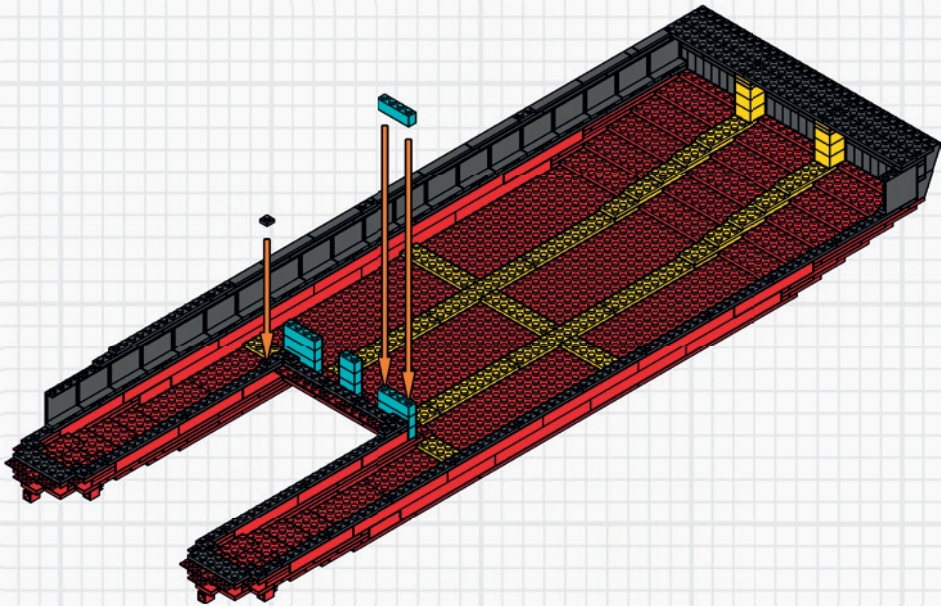
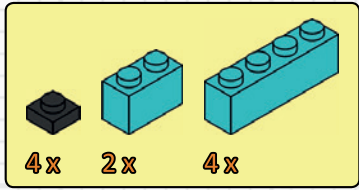



# Step 51



M38-70093



# Step 52

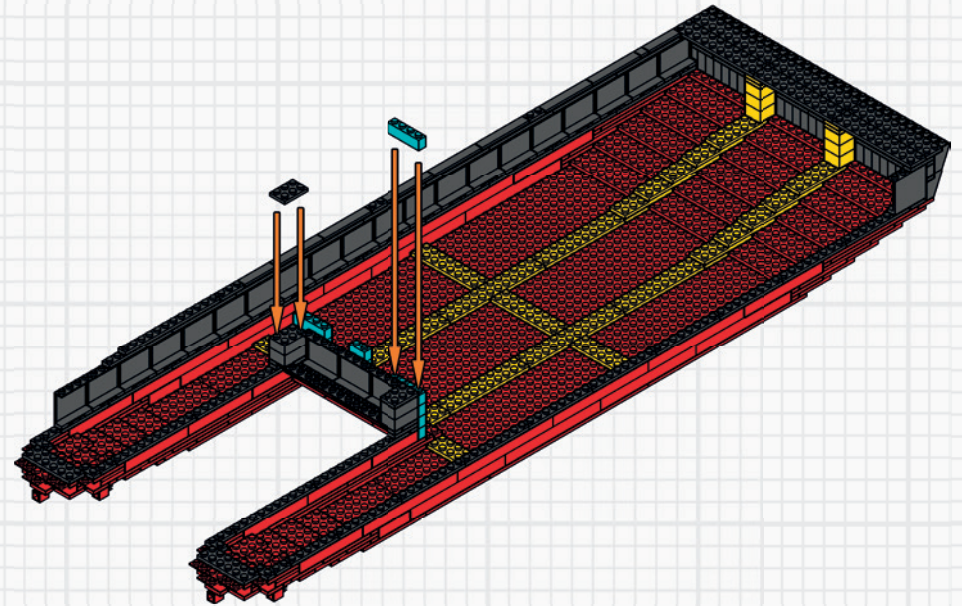
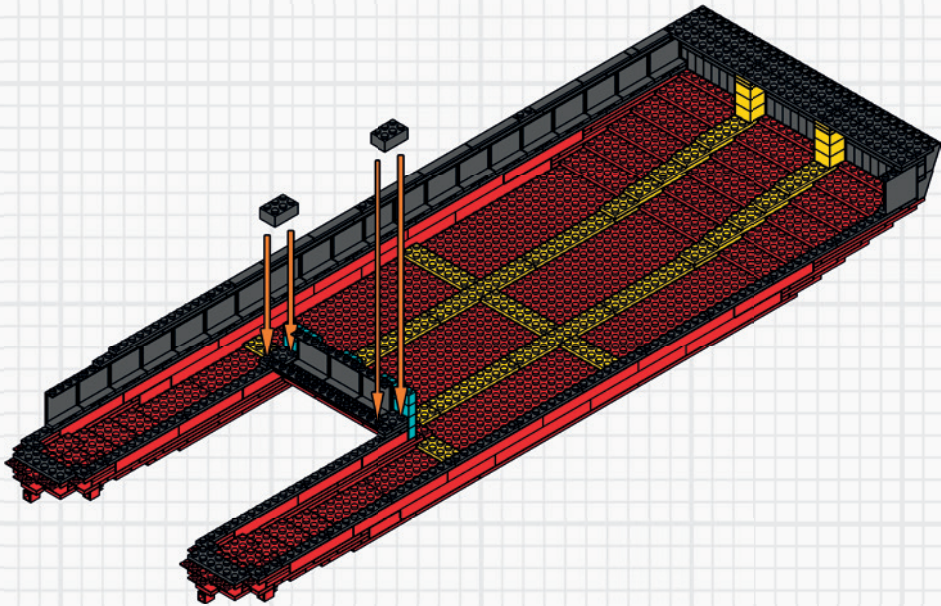
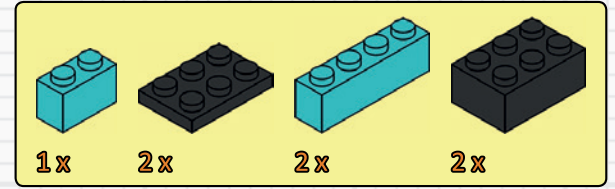
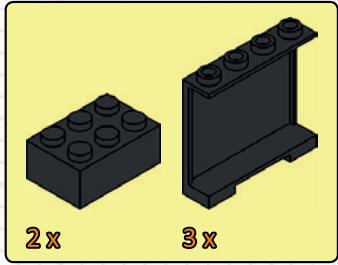

# Step 53



M38-70093



elseas

# Step 54

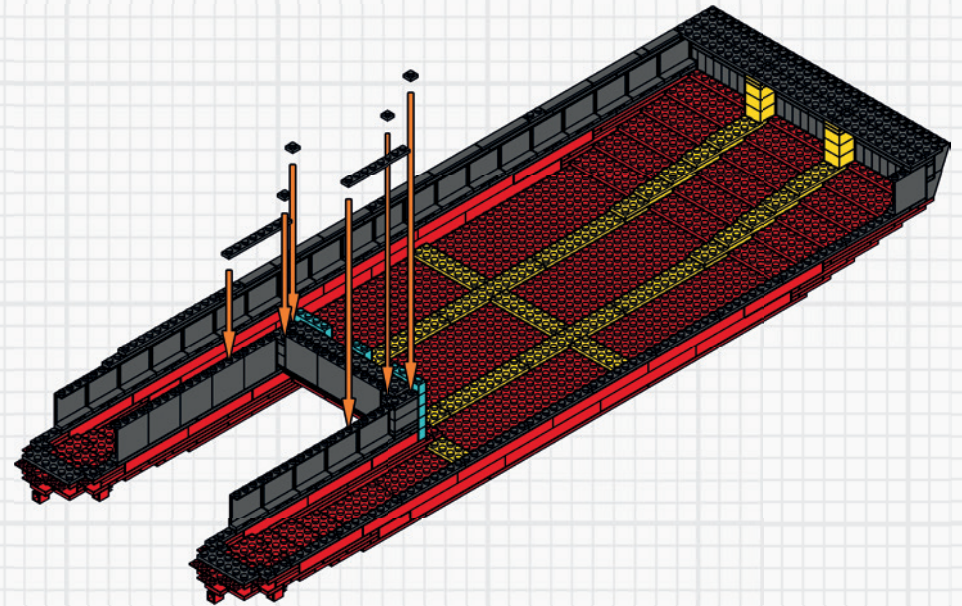
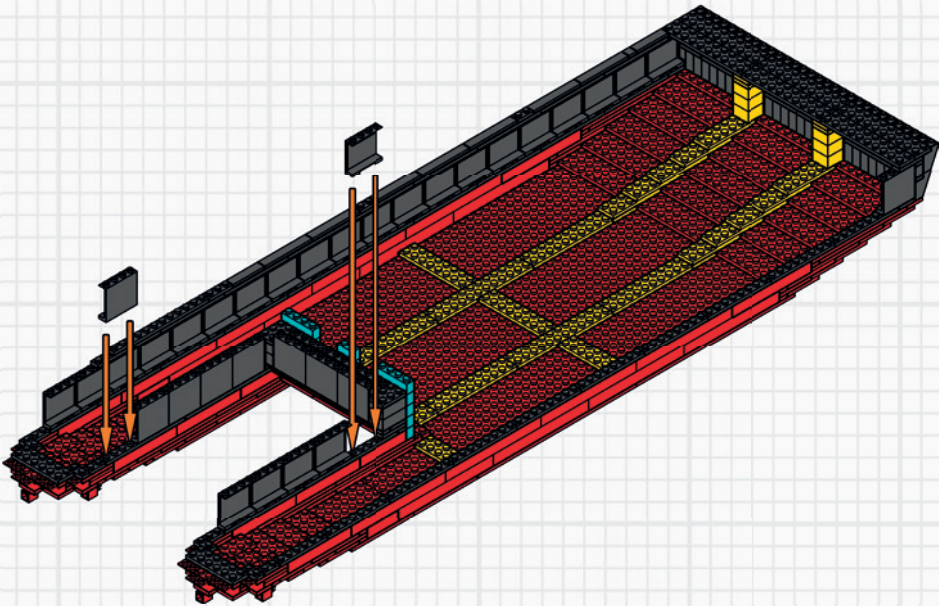
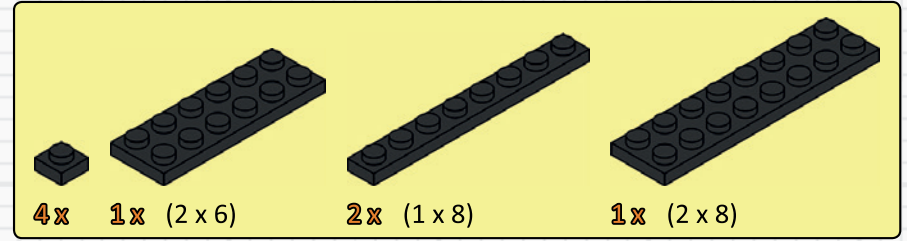
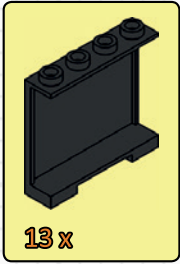



# Step 55



M38-70093



elseas

# Step 56

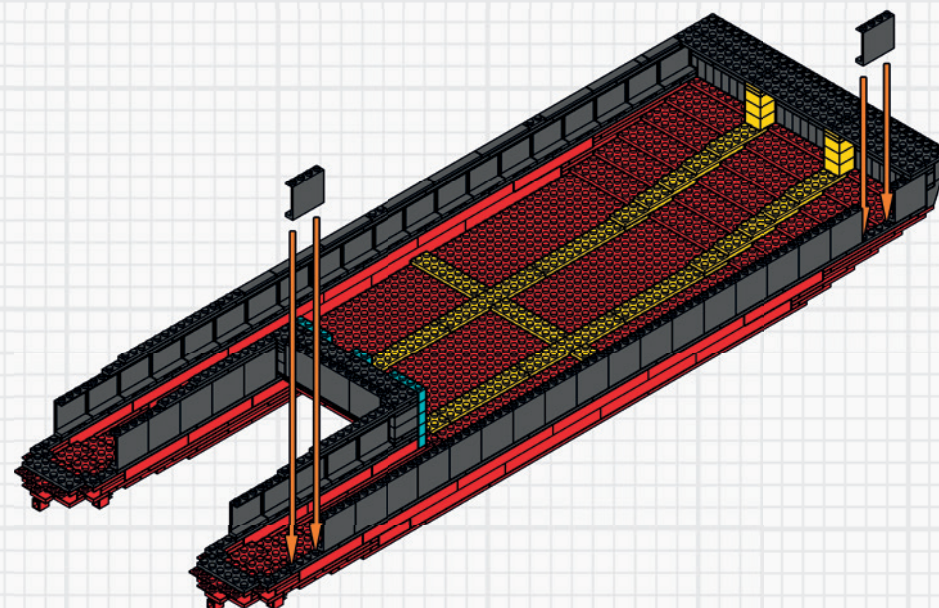
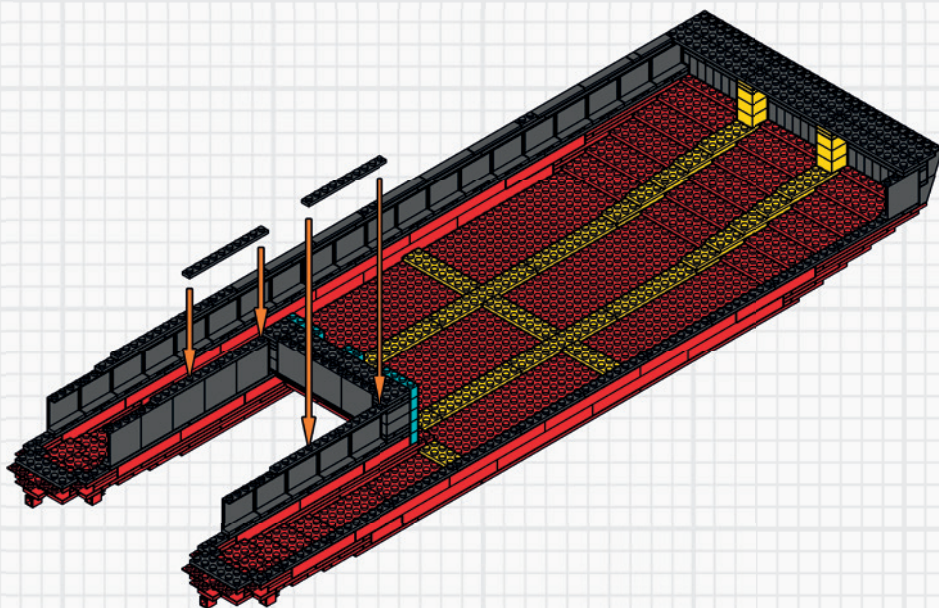
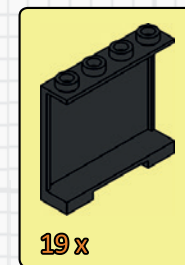
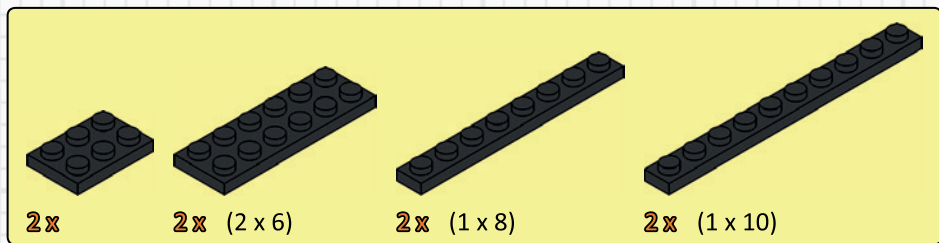

# Step 57



M38-70093



# Step 58

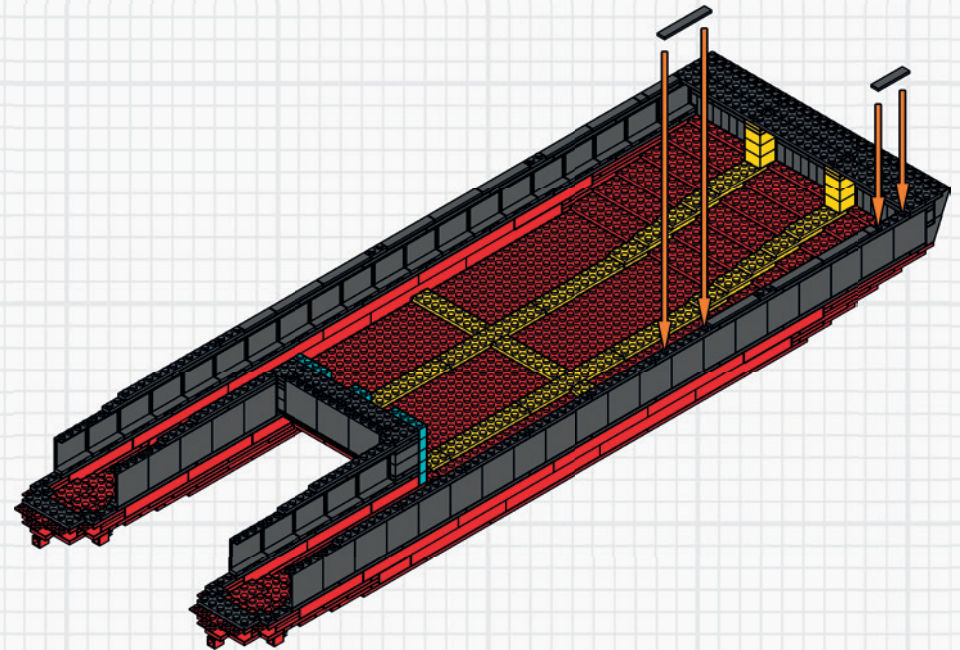
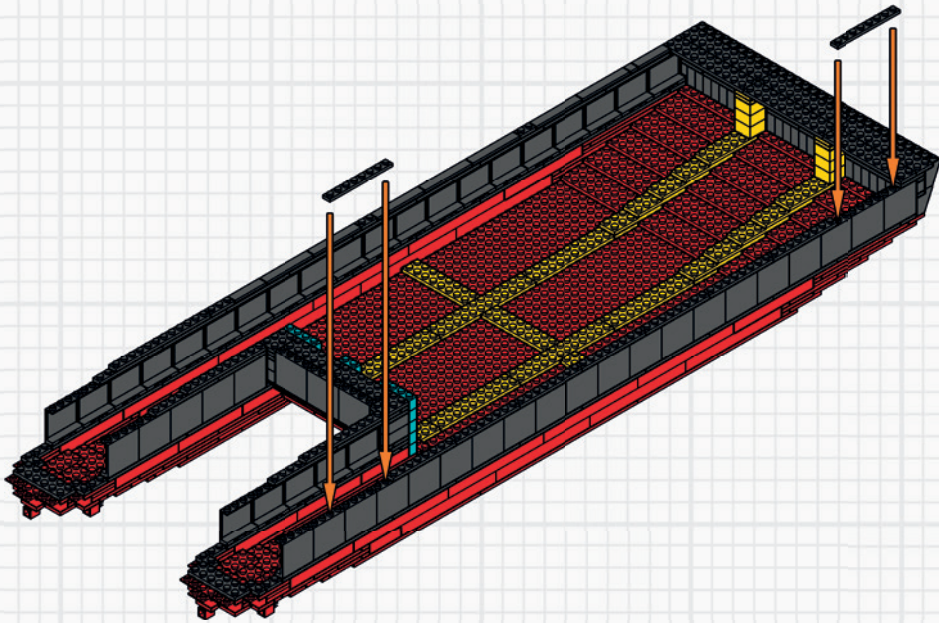
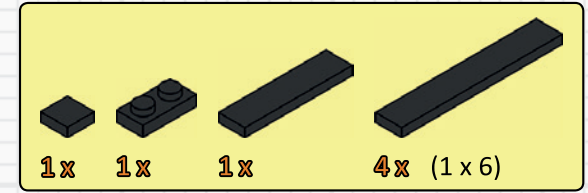
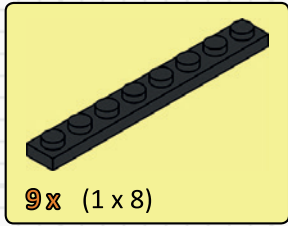



# Step 59



M38-70093



# Step 60

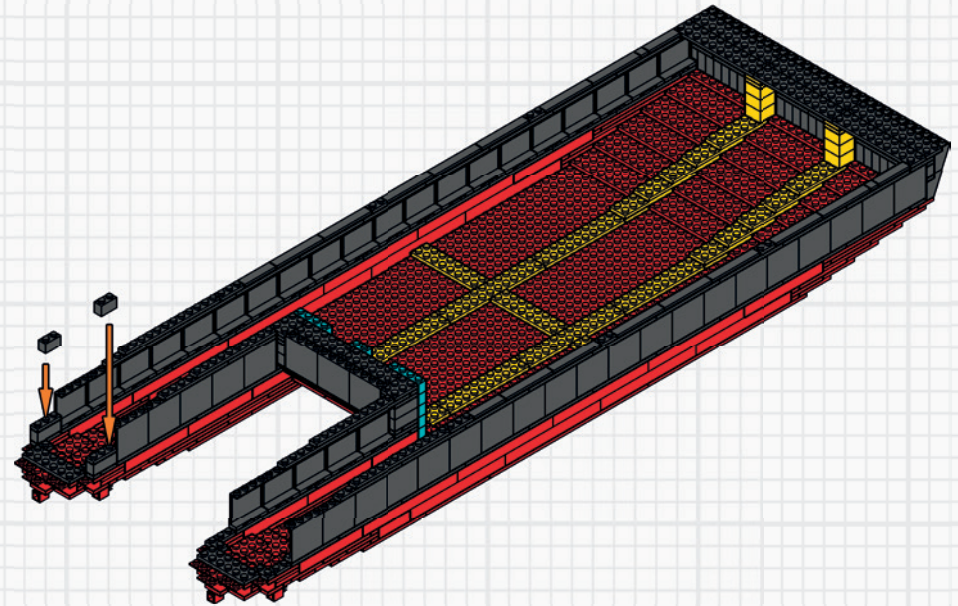
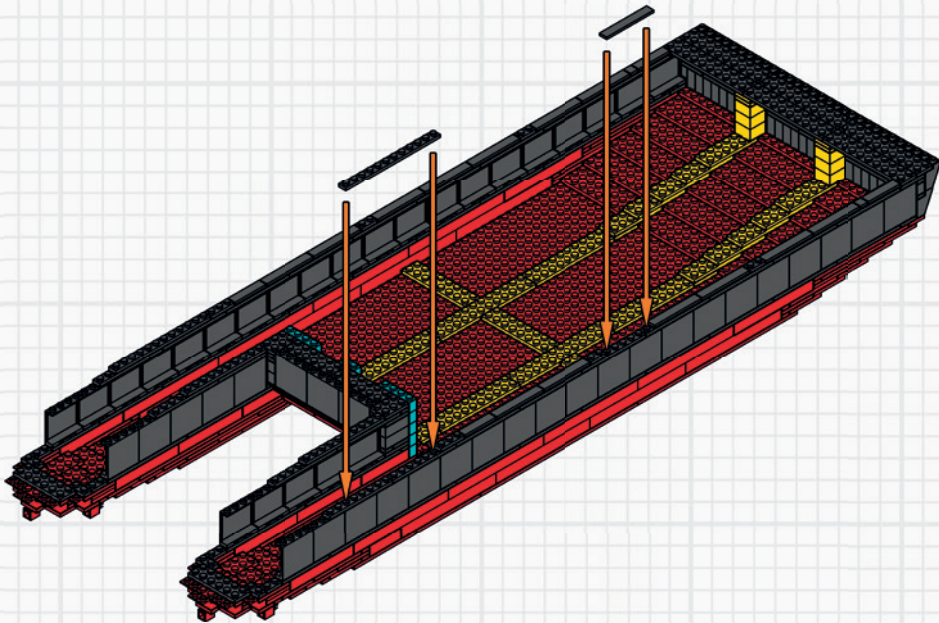
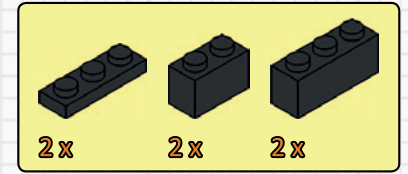
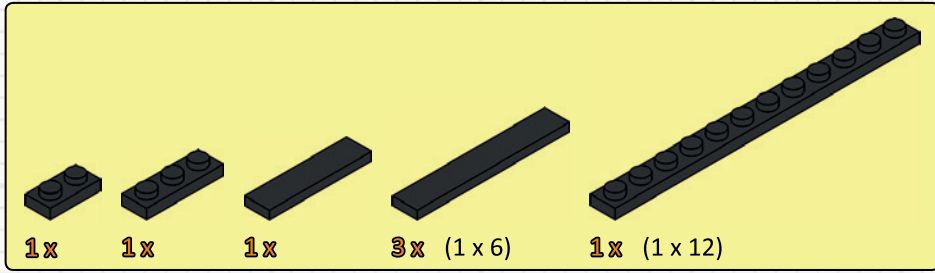

# Step 61



M38-70093



# Step 62

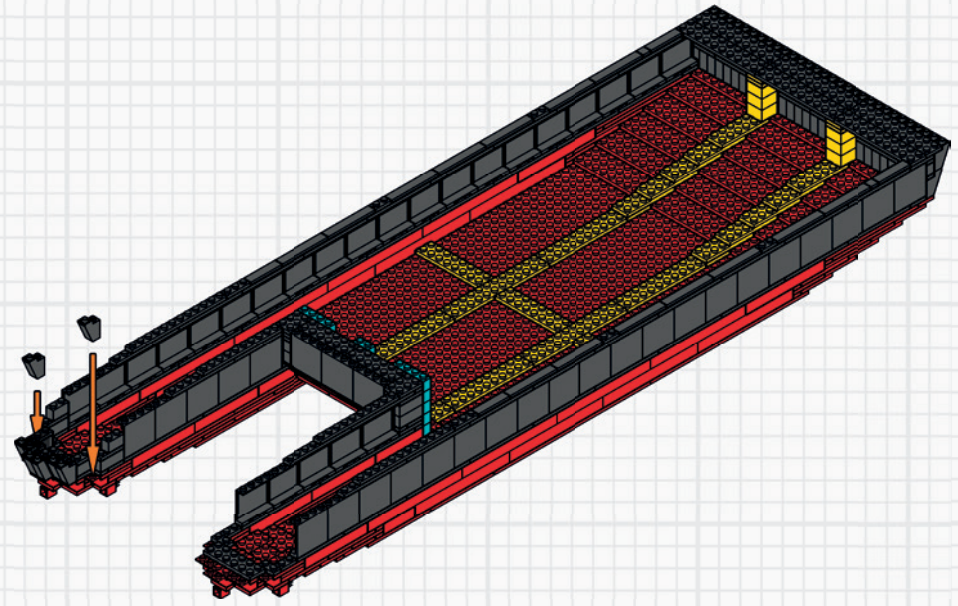
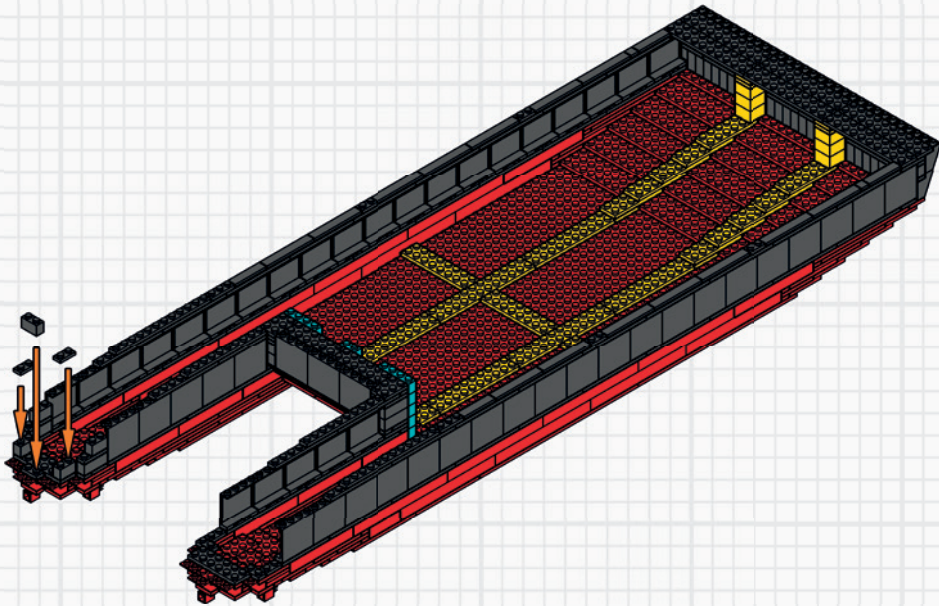
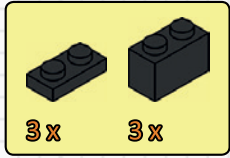



# Step 63



M38-70093



elseas

# Step 64

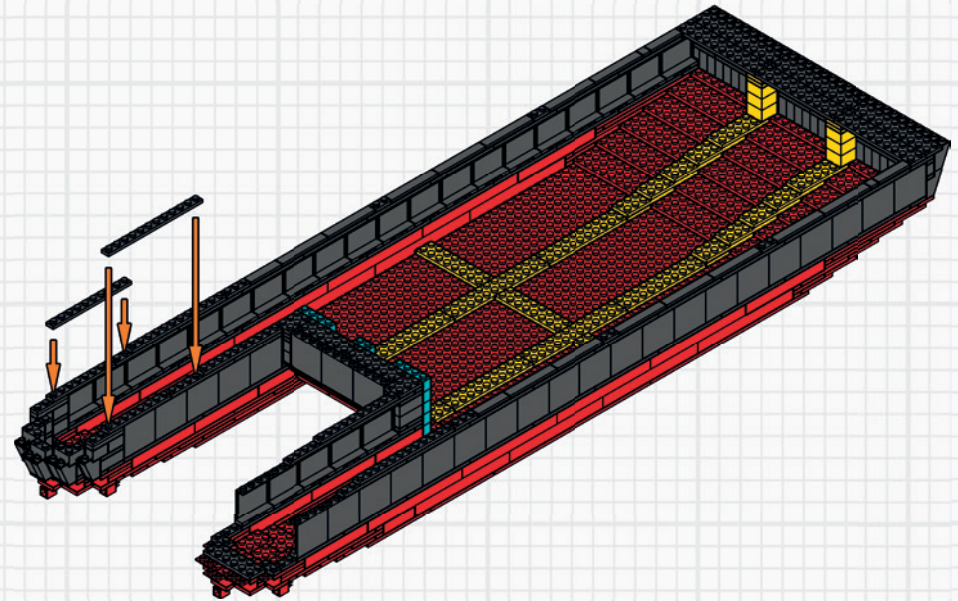
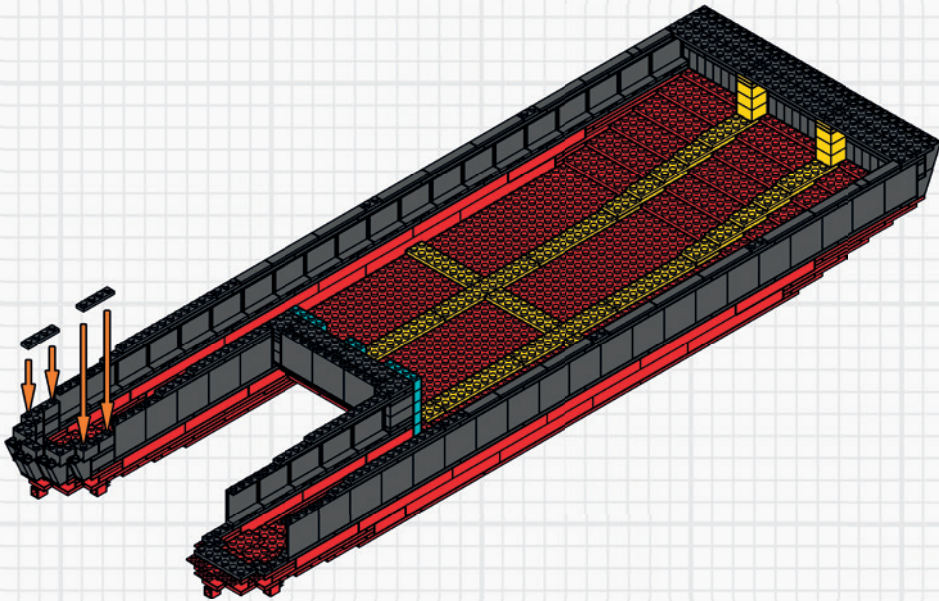
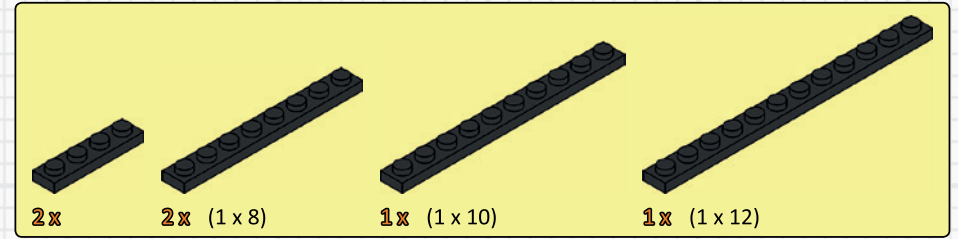
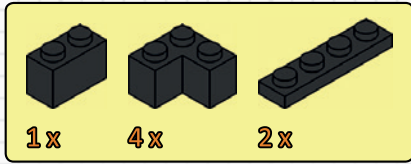

# Step 65



M38-70093



# Step 66

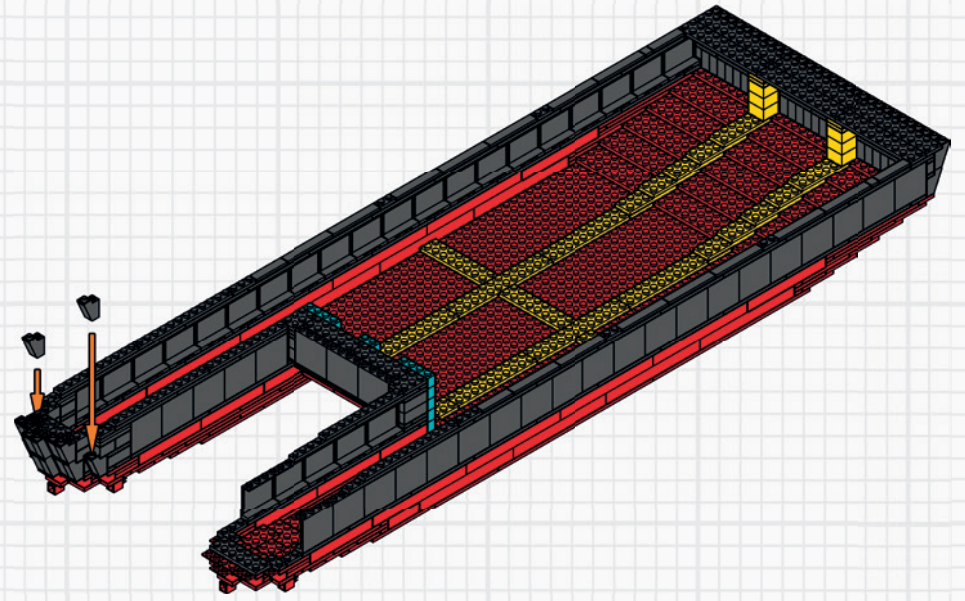
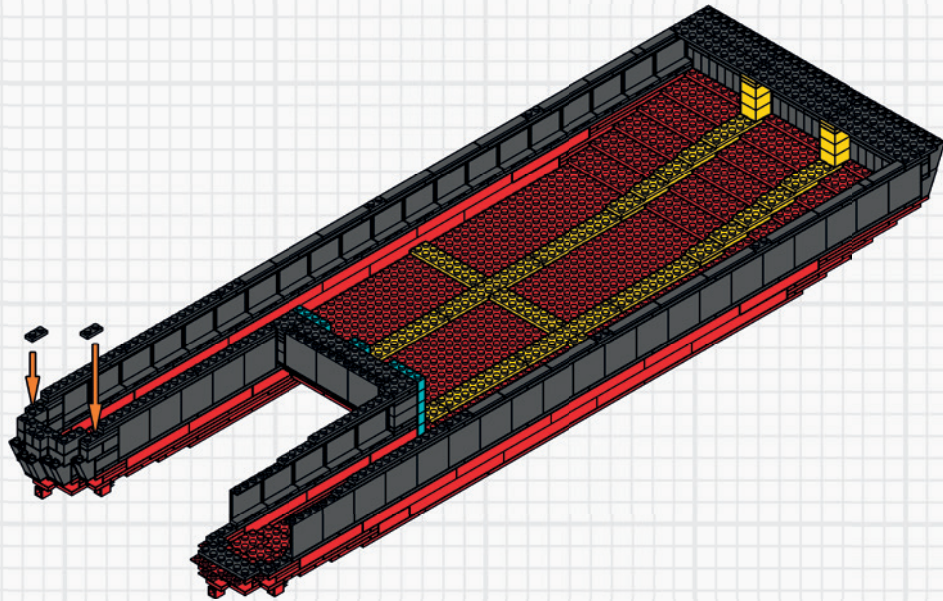
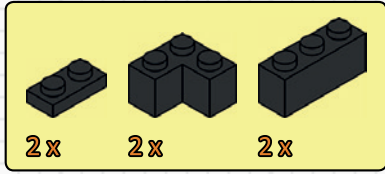



# Step 67



M38-70093



# Step 68

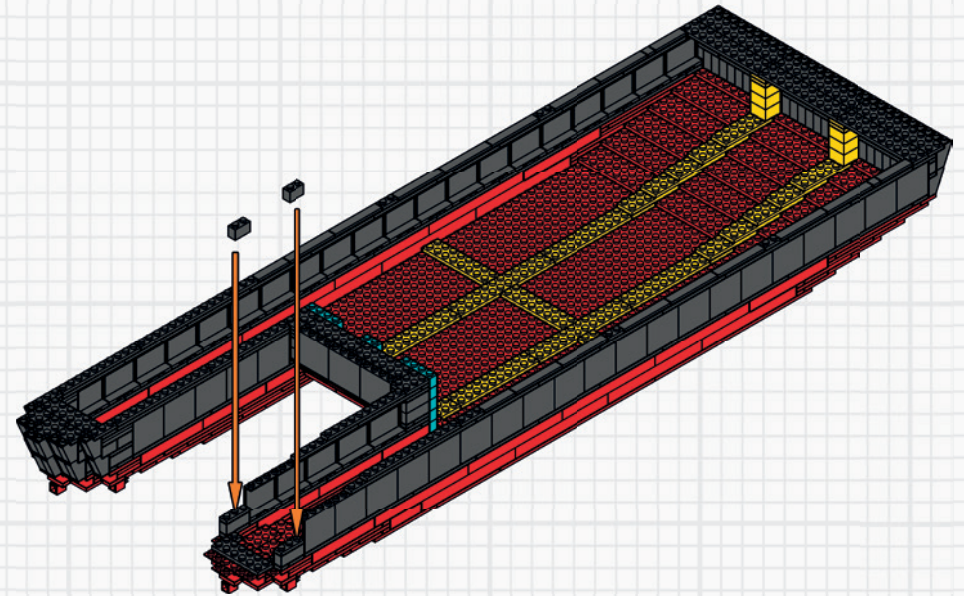
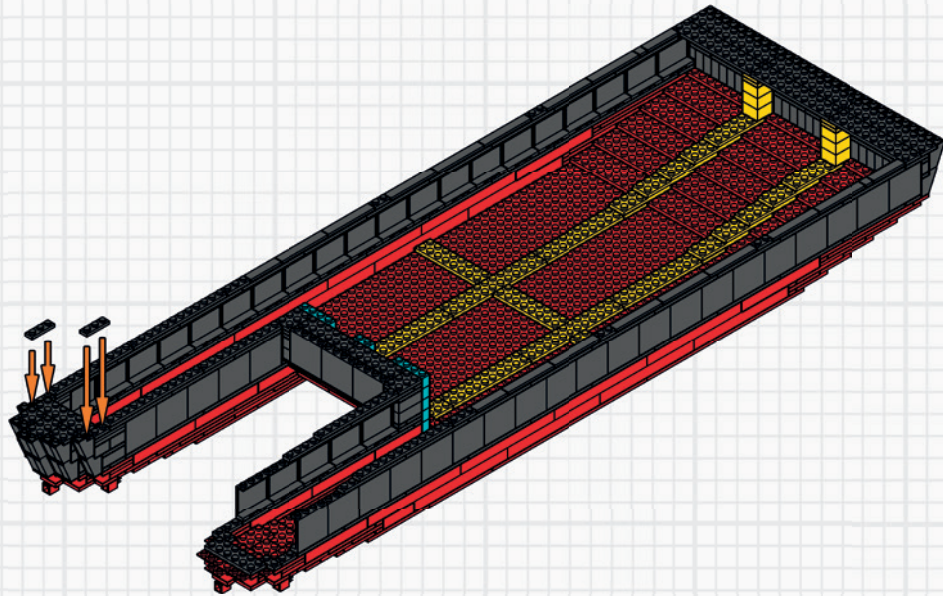
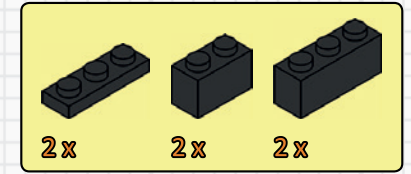
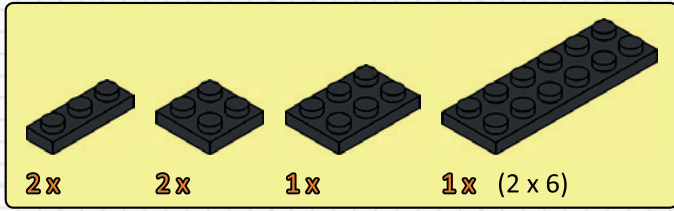

# Step 69



M38-70093



elseas

# Step 70

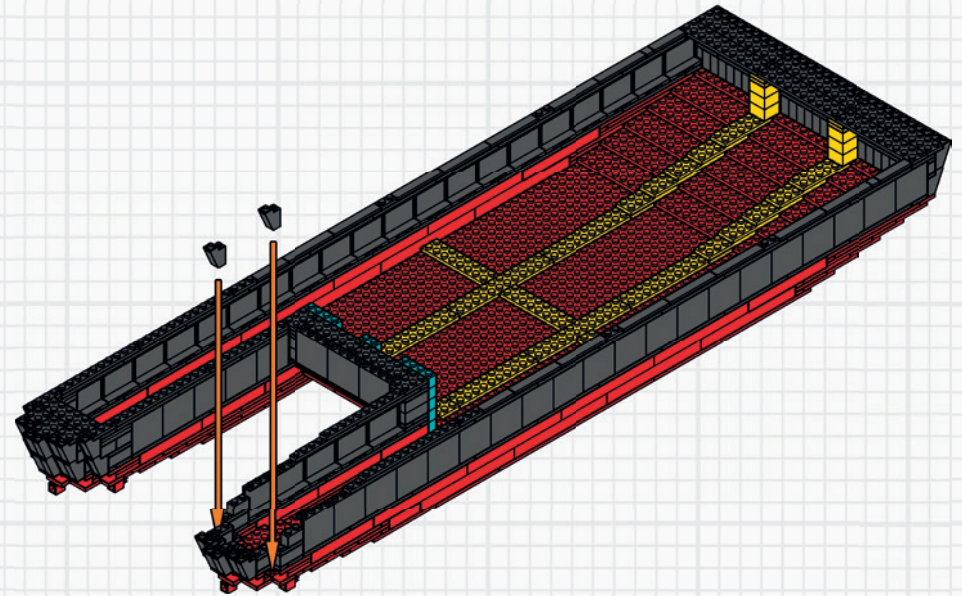
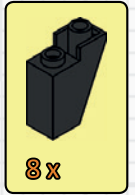
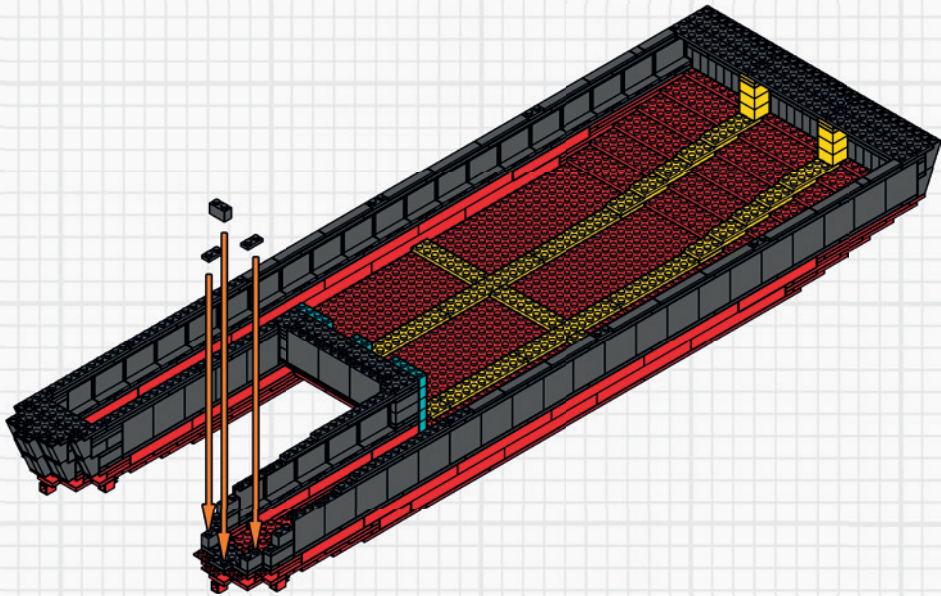
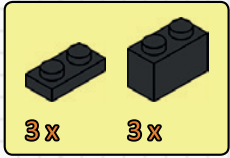



# Step 71



M38-70093



alseas

# Step 72

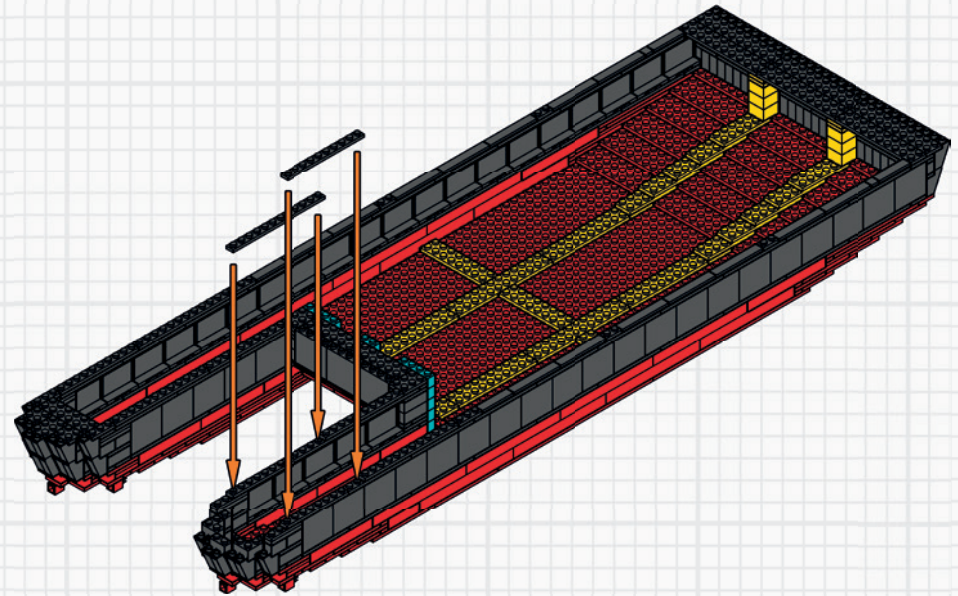
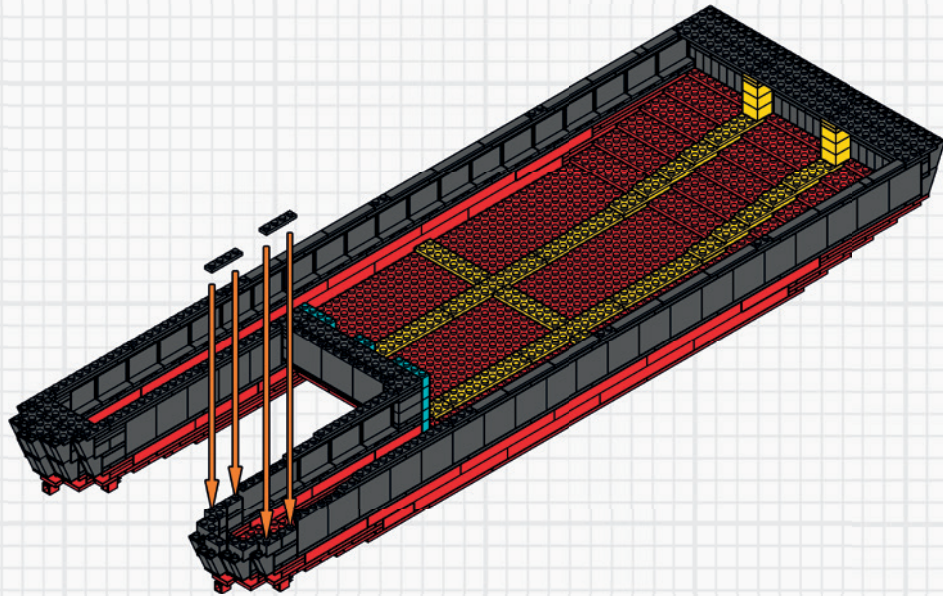
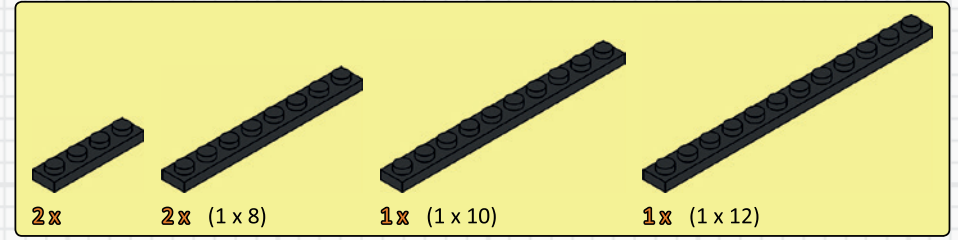
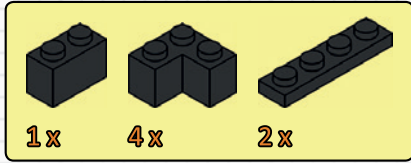

# Step 73



M38-70093



# Step 74

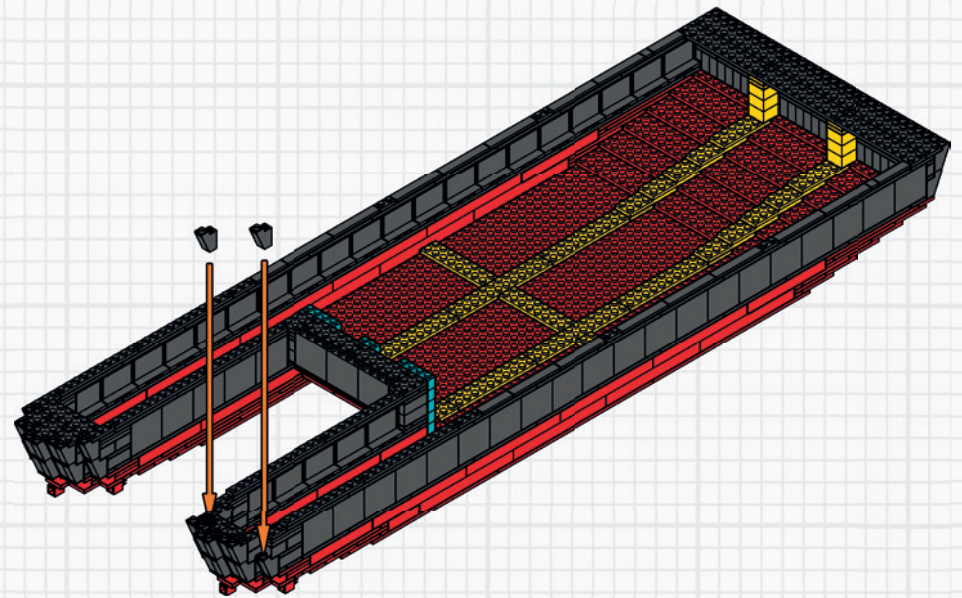
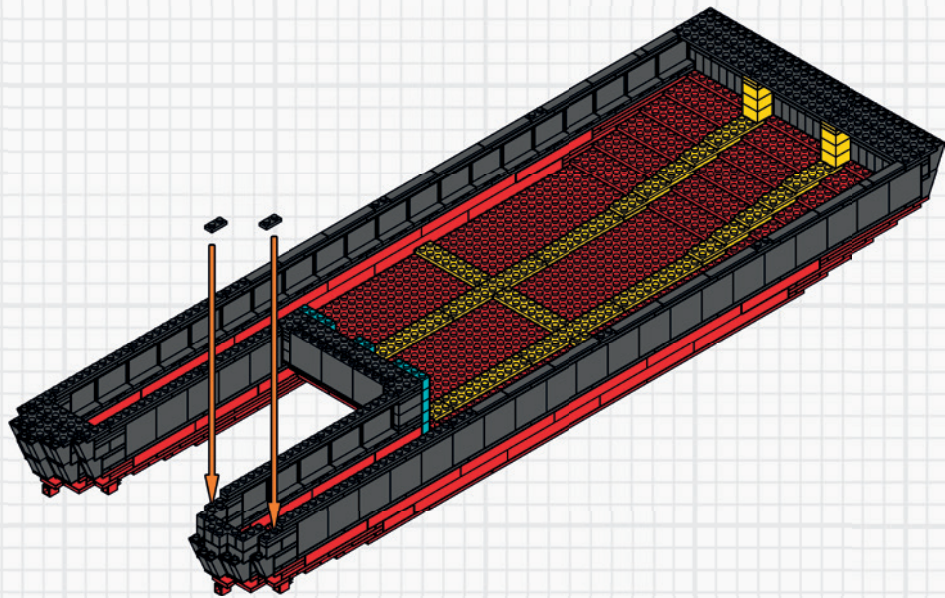
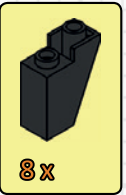
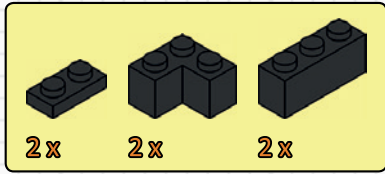



# Step 75



M38-70093



# Step 76

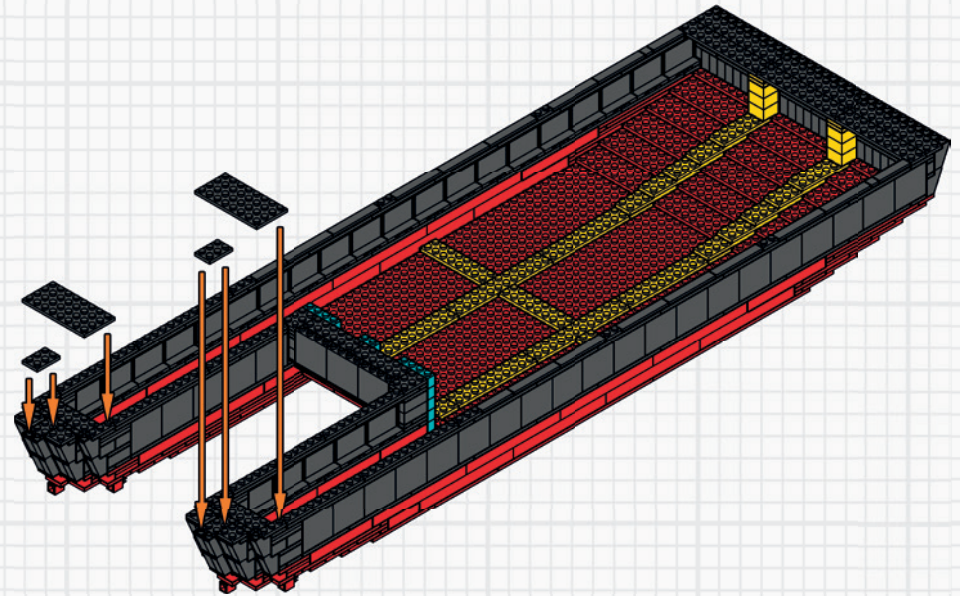
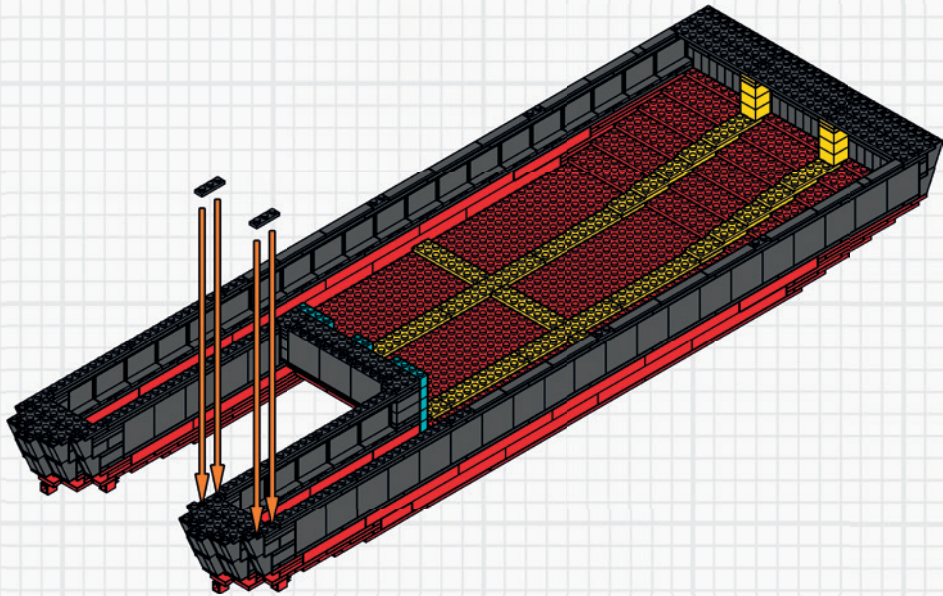
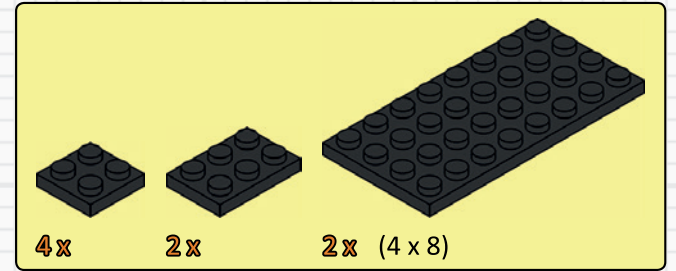
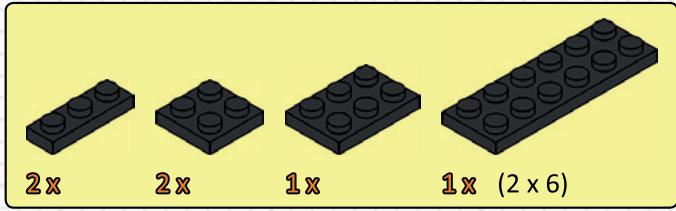

# Step 77



M38-70093



# Step 78

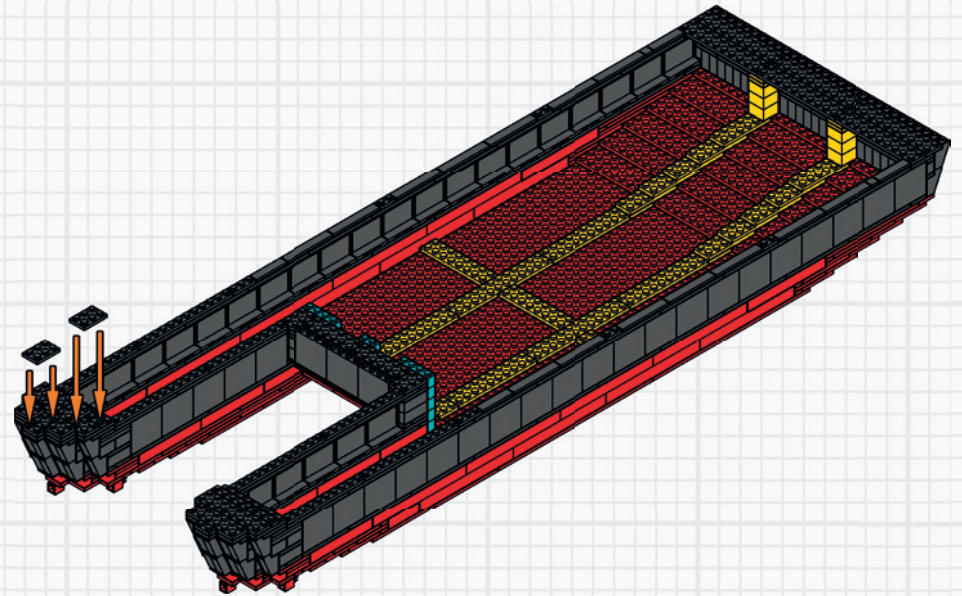
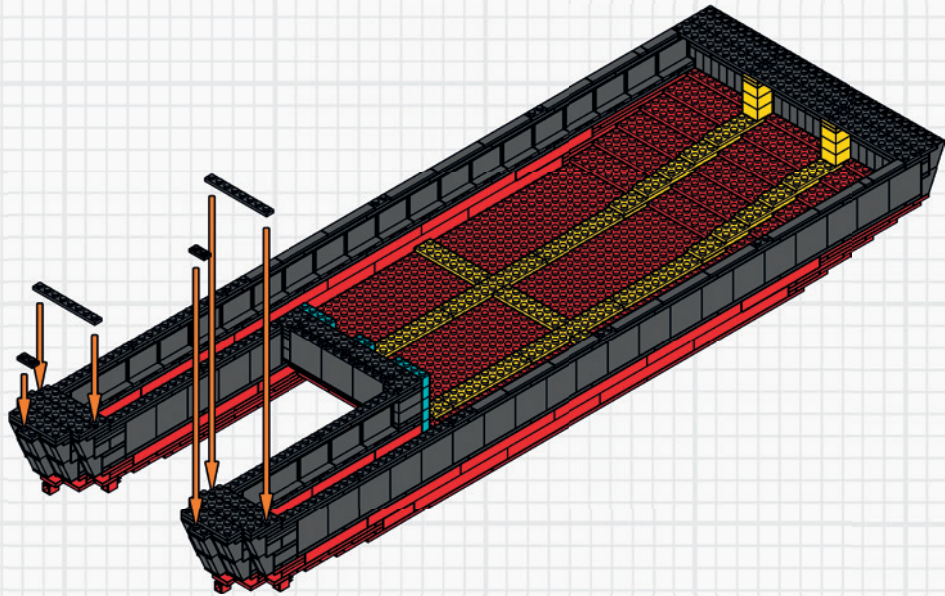
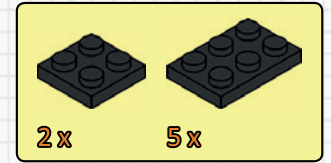
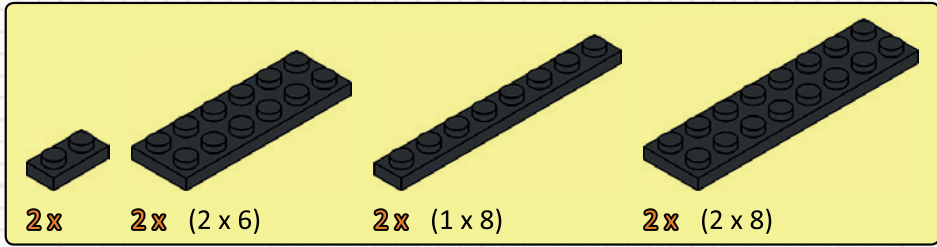



# Step 79



M38-70093



elseas

# Step 80

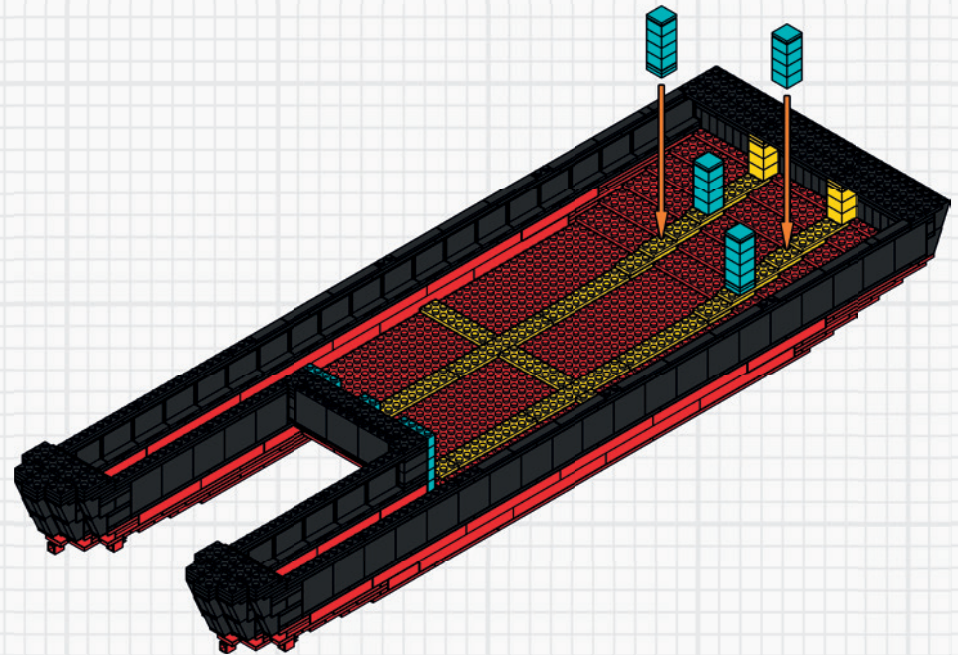
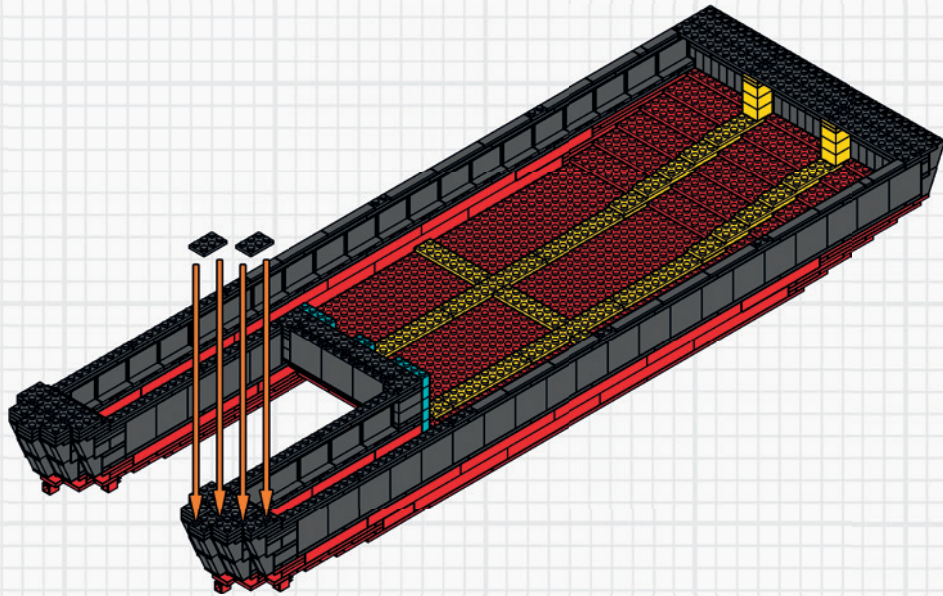
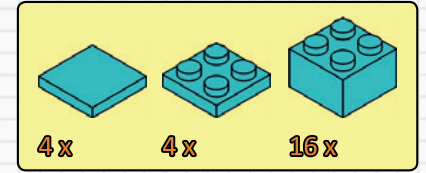
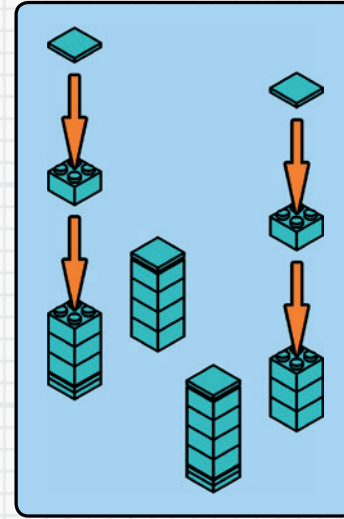
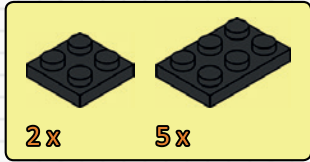

# Step 81



M38-70093



elseas

# Step 82

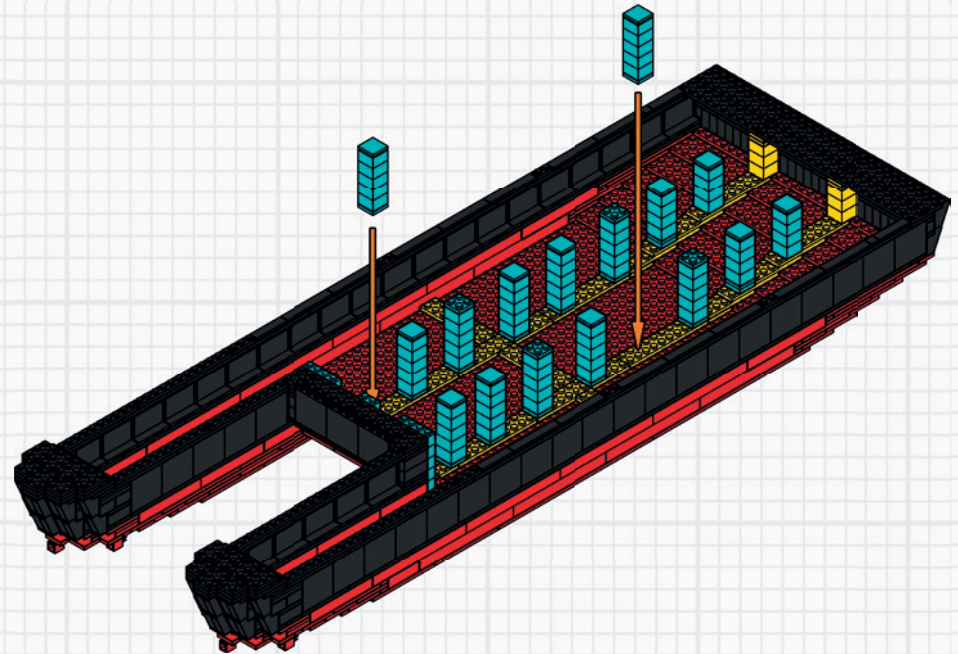
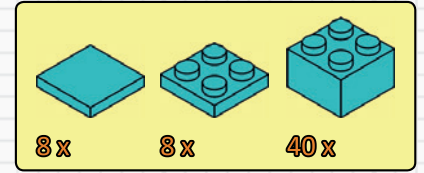
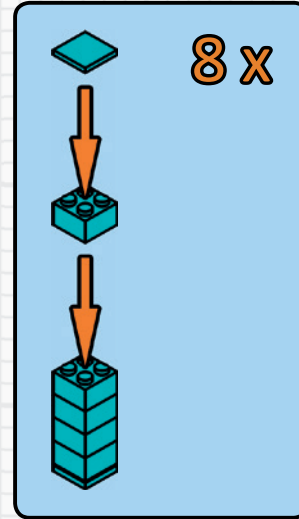
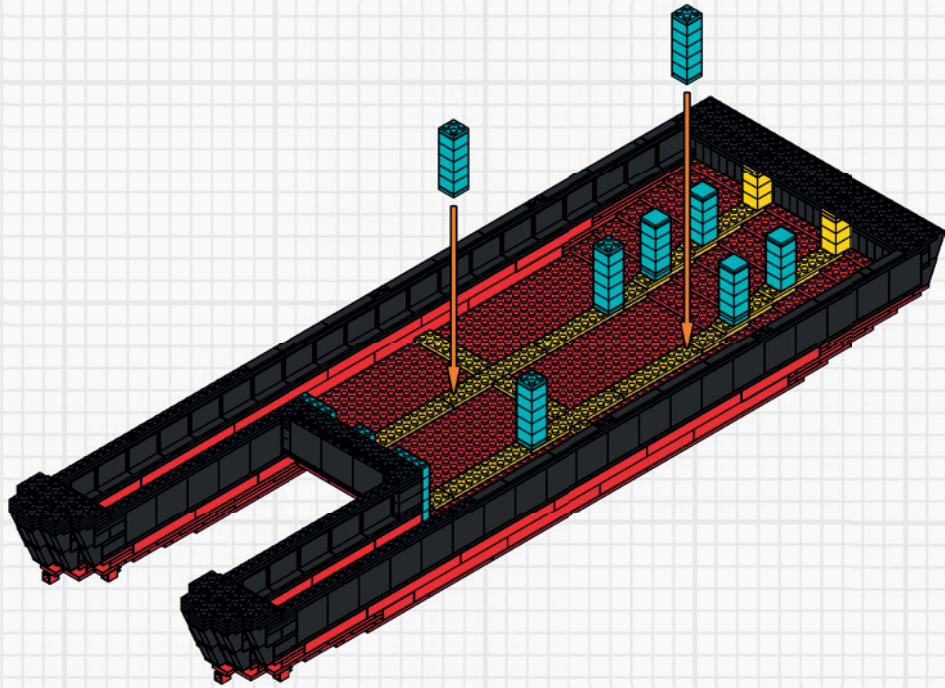
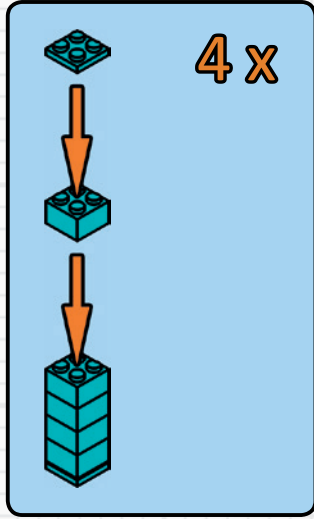
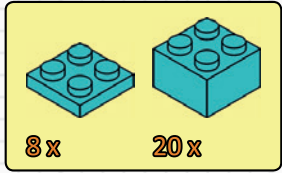



# Step 83



M38-70093



# Step 84

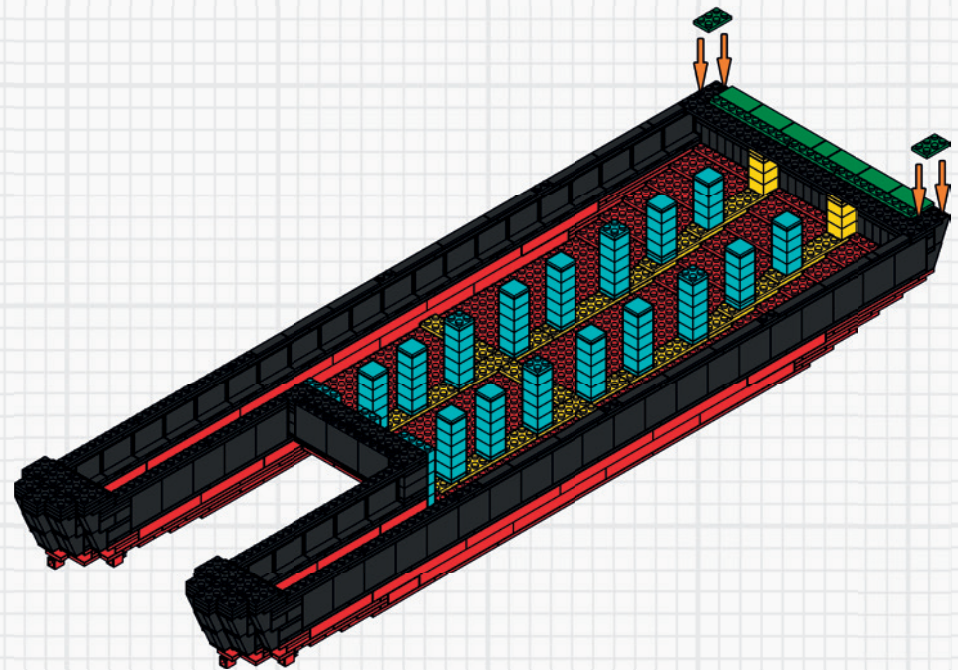
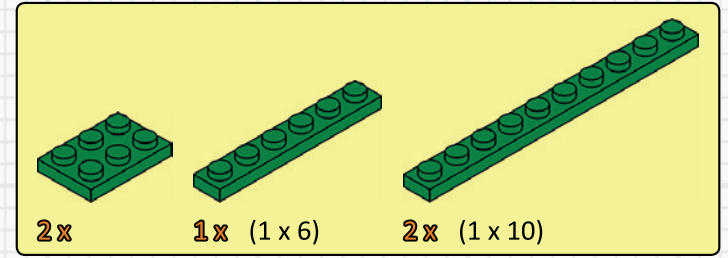
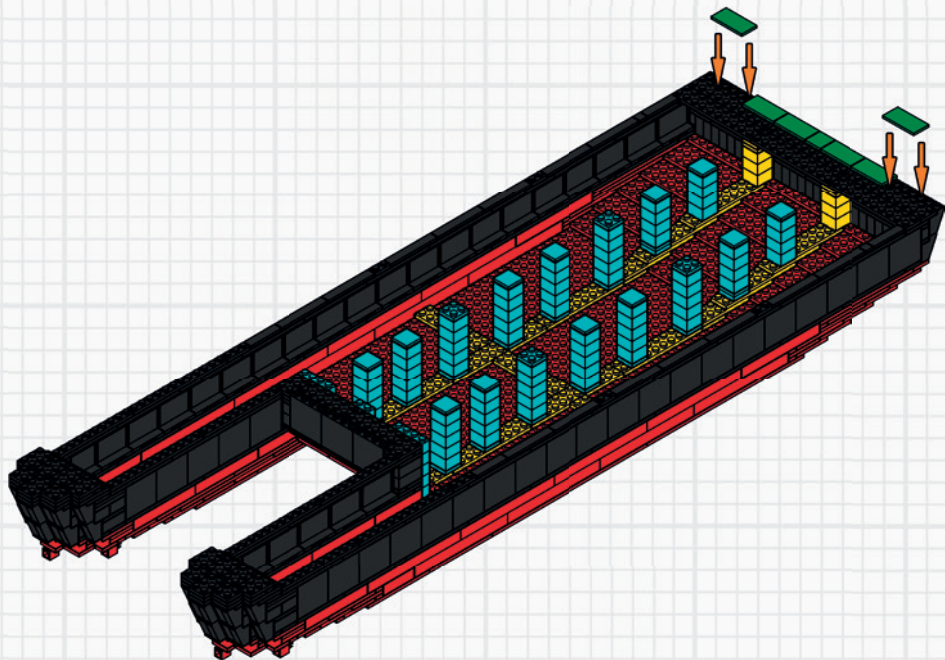
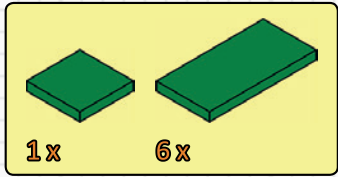

# Step 85



M38-70093



elseas

# Step 86

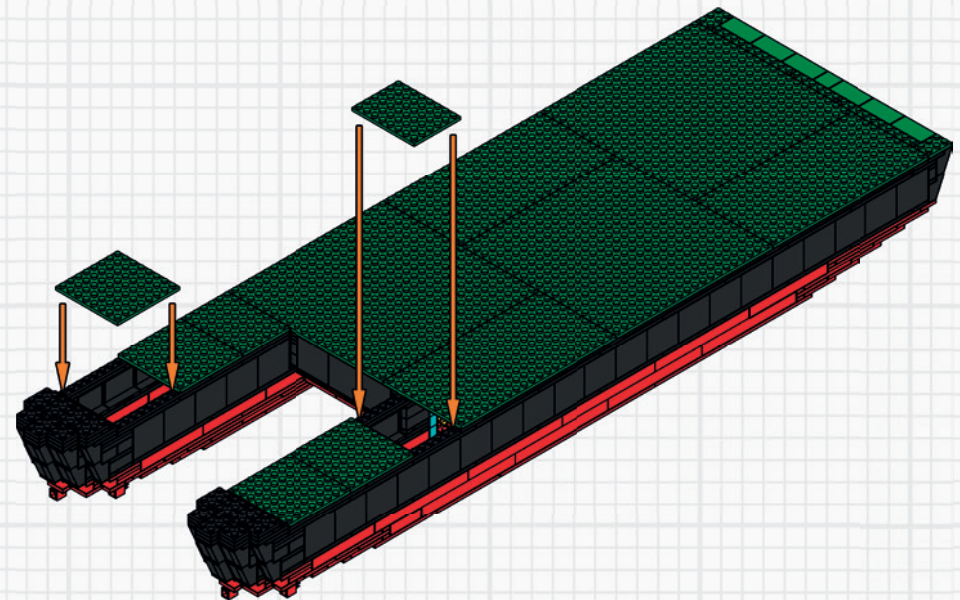
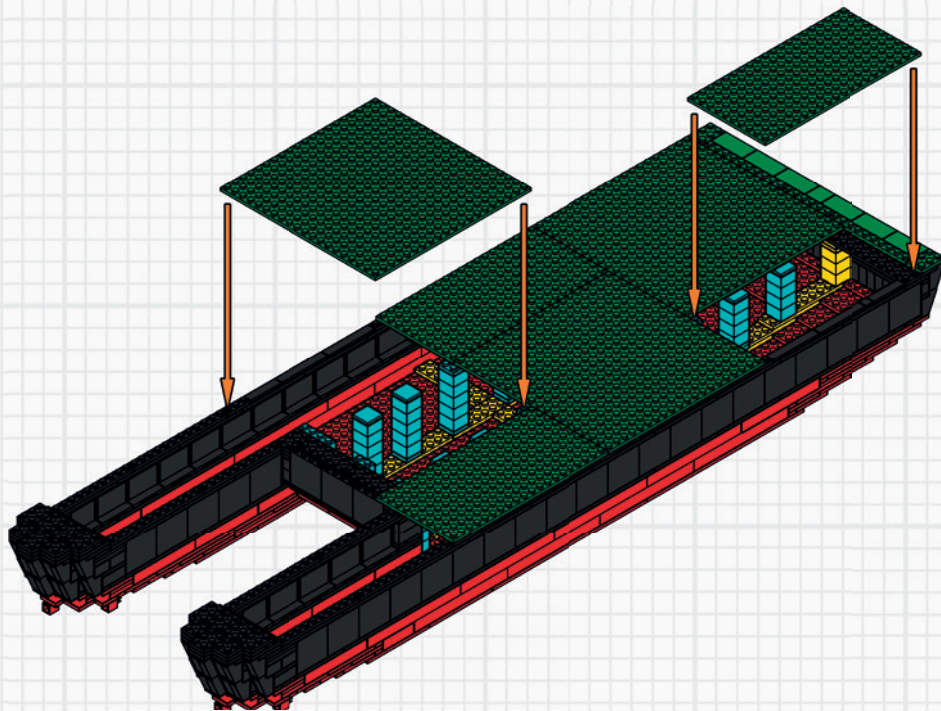
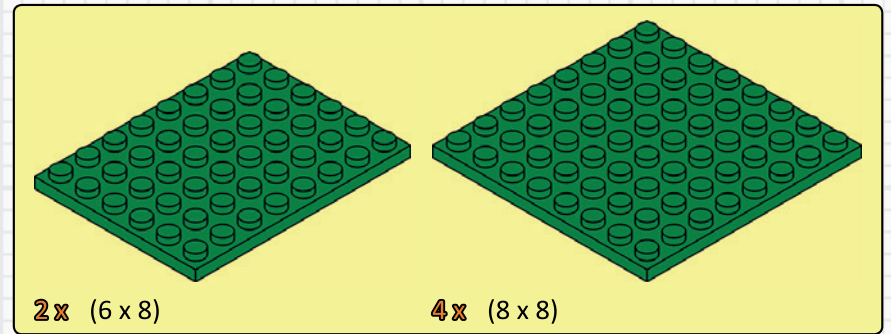
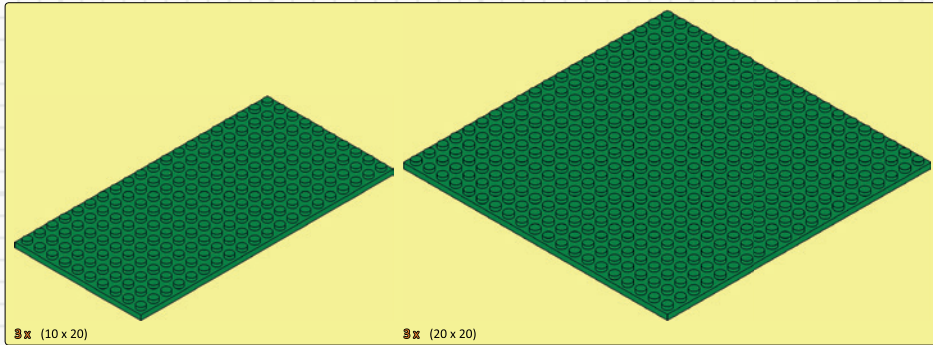



# Step 87



M38-70093



alseas

# Step 88

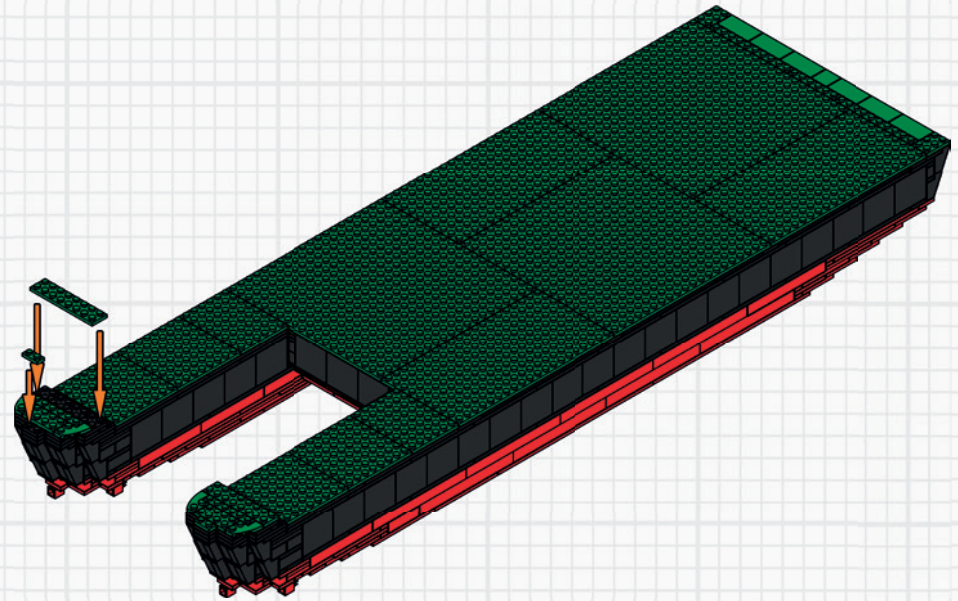
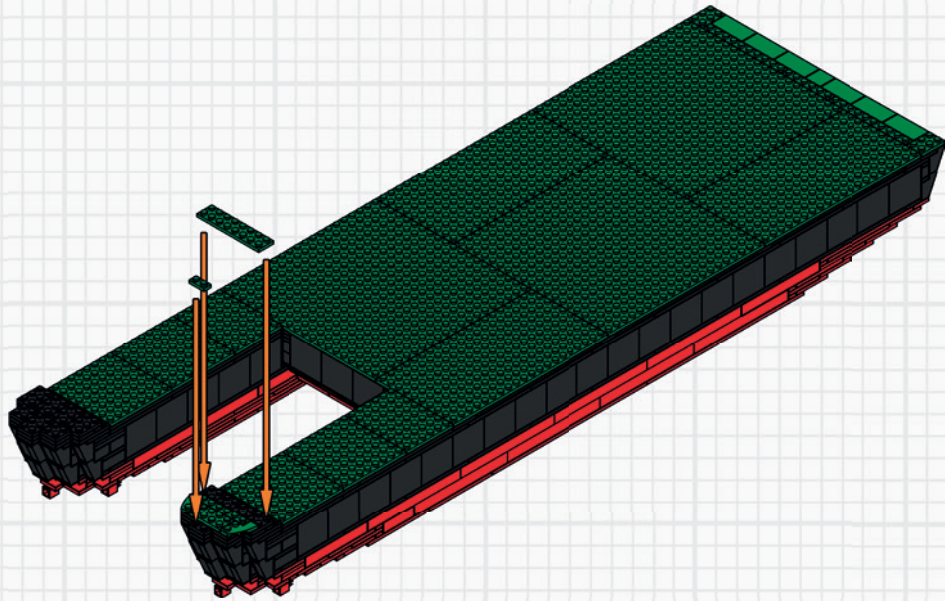
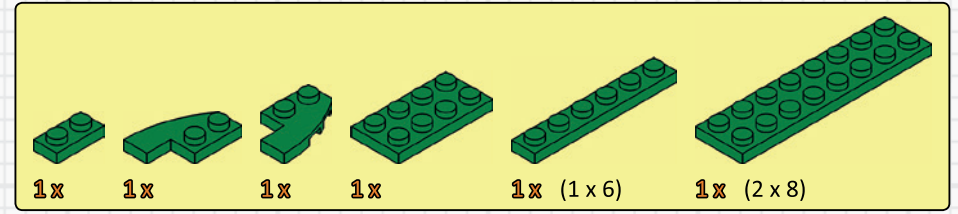
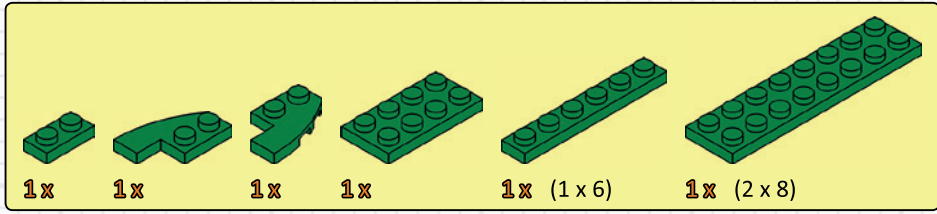

# Step 89



M38-70093



# Step 90

